

Site Rating and Analysis

<u>SITE #</u>	<u>LOCATION</u>
1	Memorial Pool Site
2	Myrick Park
3	Forest Hills Golf Course (ON TOP OF HILL)
4	Forest Hills Golf Course (BY THE ROAD)
5	Bluffview Park
6	Weigent Park
7	Roellig Park

- Riverside North was considered but ruled out because of cost to develop the site for construction.

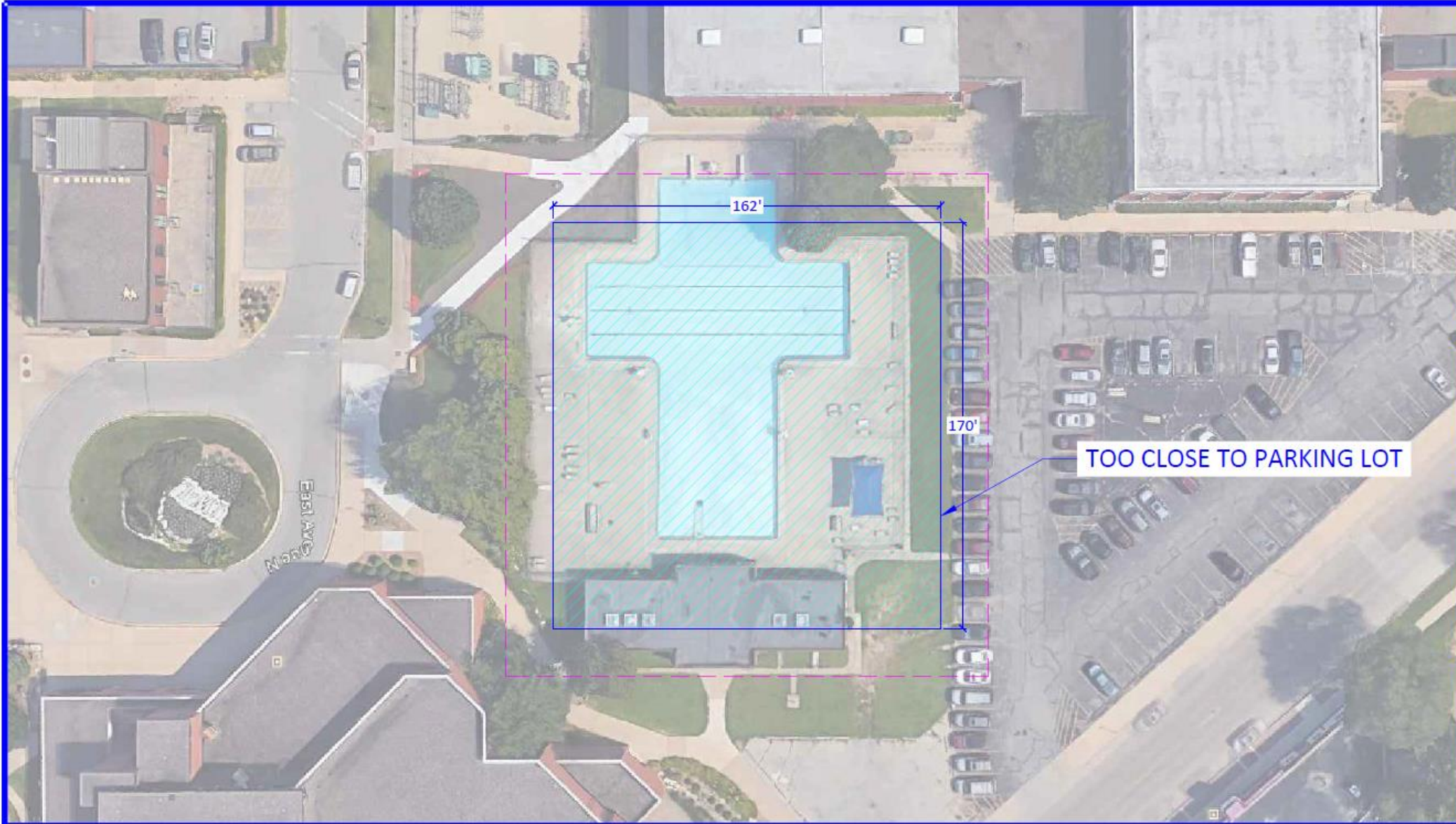

MEMORIAL POOL - SITE #1

CONCEPTUAL SITE PLAN STATISTICS

BUILDING AREA	27,540 SQ. FT.
GRADING AREA	42,420 SQ. FT.

BURBACH AQUATICS, INC.
 ARCHITECTS & ENGINEERS
"Your Quality choice for Aquatic Design!"
 WWW.BURBACHAQUATICS.COM
 BAAE@CENTURYTEL.NET

NORTH
 0' 20' 40'

DATE	2-21-2017
PROJECT	PH1-S2
CONTRACTOR	BURBACH AQUATICS, INC. 2745 W. WISCONSIN ST. #200 MILWAUKEE, WI 53227 TEL: 414.224.1111 FAX: 414.224.1111 WWW.BURBACHAQUATICS.COM
DESIGNER	CITY HALL 1ST FLOOR 400 LA CROSSE STREET LA CROSSE, WI 54601
DATE	2-21-2017
BY	ROBERT J. BURBACH, P.E., P.E.C.
APPROVED BY	

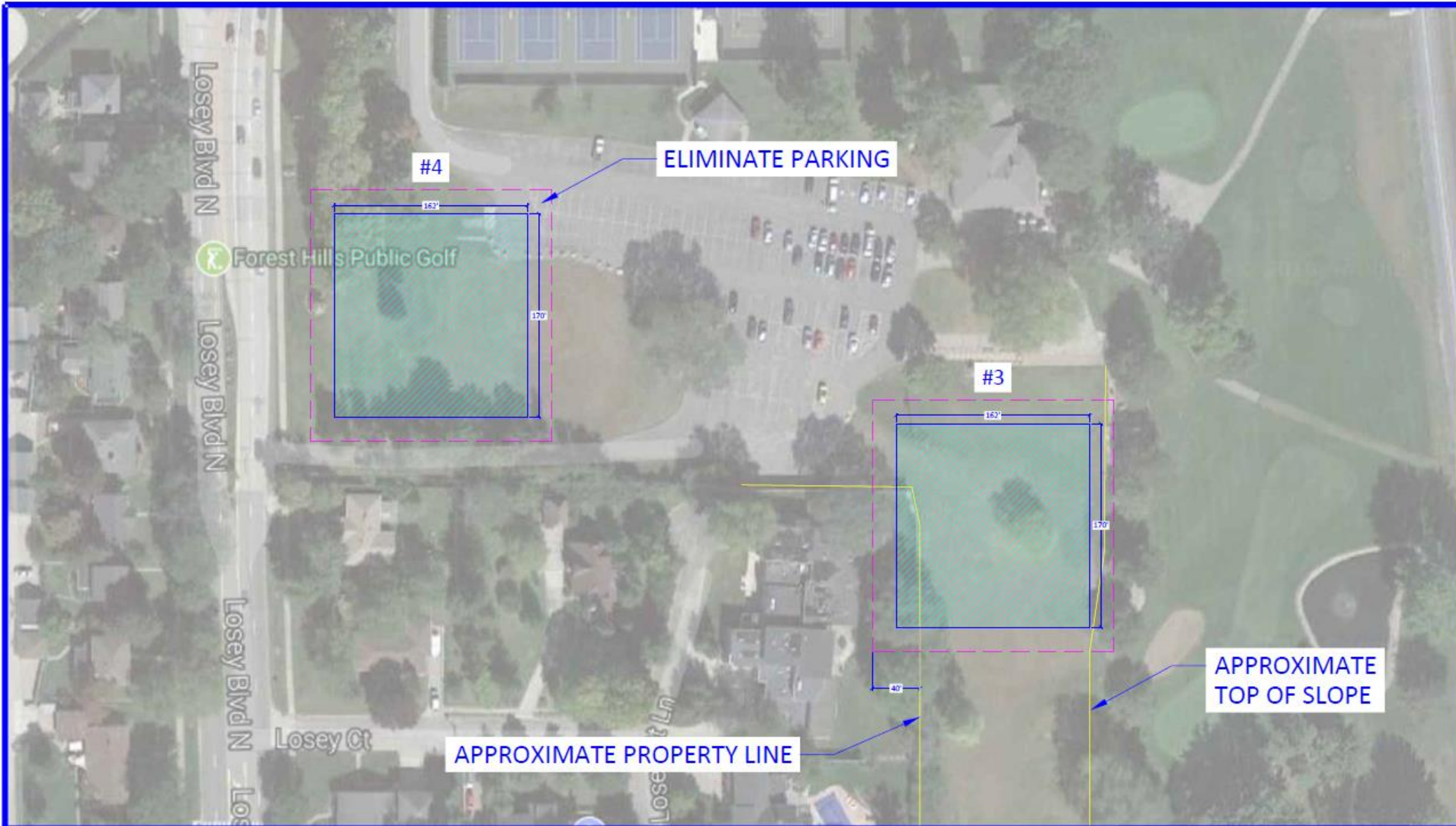

FOREST HILLS - SITES #3 AND #4

CONCEPTUAL SITE PLAN STATISTICS	
BUILDING AREA	27,540 SQ. FT.
GRADING AREA	42,420 SQ. FT.

BURBACH AQUATICS, INC.
 ARCHITECTS & ENGINEERS
"Your Quality choice for Aquatic Design!"
 WWW.BURBACHAQUATICS.COM
 BAA@CENTURYTEL.NET

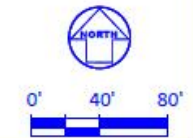

PROJECT NO. CND 0004.P01	CITY HALL 1ST FLOOR 400 LA CROSSE STREET LA CROSSE, WI 54601	CONSULTANT BURBACH AQUATICS, INC. ARCHITECTS & ENGINEERS 5014 5TH AVE. SUITE 200 - F.A. BLDG #3731 FORT BELLEVILLE, ILLINOIS 62209 WWW.BURBACHAQUATICS.COM
DRAWING NO. PH1-S2	PROJECT SITE EVALUATION - FOREST HILLS LACROSSE FAMILY AQUATIC CENTER	DATE 2-21-2017



WEIGENT PARK - SITE #6

BURBACH AQUATICS, INC.
 ARCHITECTS & ENGINEERS

"Your Quality choice for Aquatic Design!"

WWW.BURBACHAQUATICS.COM
 BAAE@CENTURYTEL.NET

NORTH

0' 40' 80'

CONCEPTUAL SITE PLAN STATISTICS	
BUILDING AREA	27,540 SQ. FT.
GRADING AREA	42,420 SQ. FT.

PROJECT NO. CAD DWG. FILE © BURBACH AQUATICS, INC. 2017 DESIGN APPROVED: [Signature] DATE: 2/21/2017	CITY HALL 1ST FLOOR 400 LA CROSSE STREET LA CROSSE, WI 54601	CONSULTING ENGINEER BURBACH AQUATICS, INC. 1100 N. 10TH ST. SUITE 200 WAUKESHA, WI 53186 WWW.BURBACHAQUATICS.COM	SHEET NO. DATE REVISIONS
SITE EVALUATION - WEIGENT PARK LACROSSE FAMILY AQUATIC CENTER		PH1-S2	



ROELLIG PARK - SITE #7

CONCEPTUAL SITE PLAN STATISTICS

BUILDING AREA	27,540 SQ. FT.
GRADING AREA	42,420 SQ. FT.



OWNER BURBACH AQUATICS, INC. ARCHITECTS & ENGINEERS 1000 W. WISCONSIN ST. - 2ND FLOOR MADISON, WI 53706-1640 TEL: 608.261.1111 WWW.BURBACHAQUATICS.COM	
PROJECT NO. CHD 2016 715	DATE
PROJECT NAME CITY HALL 1ST FLOOR LACROSSE FAMILY AQUATIC CENTER LACROSSE, WI 54601	DATE 2-21-2017
PROJECT SITE EVALUATION - ROELLIG PARK LACROSSE FAMILY AQUATIC CENTER	
SCALE PH1-S2	

Site Rating Table								
Category	Maximum Points	Sites						
		1	2	3	4	5	6	7
1 Sanitary Sewer	5	3	3	3	4	4	4	1
2 Watermain	5	4	2	4	4	4	4	1
3 Telephone	3	3	3	3	3	3	3	2
4 Electric	10	10	5	8	8	5	5	5
5 Storm Sewer	10	3	10	10	10	10	10	10
6 Natural Gas	3	3	2	3	3	3	3	3
7 Topography	10	9	3	7	9	7	10	10
8 Surrounding Occupancies	10	5	10	10	10	6	7	10
9 Vehicular Traffic	10	10	6	10	10	7	8	10
10 Pedestrian Traffic	10	10	8	8	8	8	10	8
11 ADA Accessibility	5	5	5	4	5	3	5	5
12 Lighting	5	5	5	5	5	5	5	5
13 Flood Prone Area	20	20	15	20	18	20	20	15
14 Groundwater	20	20	10	20	20	20	20	10
15 Hydraulic Considerations	20	15	15	20	20	17	18	15
16 Site Restrictions	10	5	5	2	8	7	8	8
17 Exposure	10	10	10	5	10	5	8	10
18 Availability of Land	10	10	10	10	10	10	10	10
Total Points	176	150	127	151	165	144	158	138

ENGINEERING SITE RATING TABLE

SITE # LOCATION

- 1 Memorial Pool Site
- 2 Myrick Park
- 3 Forest Hills Golf Course (ON TOP OF HILL)
- 4 Forest Hills Golf Course (BY THE ROAD)
- 5 Bluffview Park
- 6 Weigent Park
- 7 Roellig Park

Riverside North was considered but ruled out.

Results of unweighted rating:

- #1 Forest Hills Lower
- #2 Weigent
- #3 Forest Hills Upper
- #4 Memorial Pool Site



Decision Making Matrix

Attribute Definition and Assigning Importance Factor

<u>Attribute</u>	<u>Assigned Importance</u>
Pedestrian Traffic and Accessibility	8
Site Restrictions - space, parking, fire code, etc	10
Utilities - electric, gas, water, sanitary	3
Exposure - visibility to public	5
Availability of Land	1
Topography, Flood Prone, Hydraulic, ground water	10
Surrounding Occupancies	8
Vehicular Traffic	5



Weighted Site Rating Table

	Importance Factor (1-10)	8	10	3	5	1	10	8	5	50
		16%	20%	6%	10%	2%	20%	16%	10%	100%
Site Description		Site Restrictions (ie Parking and Pedestrian Space)		Utilities	Exposure	Availability of Land	Topography, Flood Prone, Hydraulic Considerations and GroundWater	Surrounding Occupancies	Vehicular Traffic	Score
1 Memorial Pool Location		100	50	77	100	100	91	50	100	79
2 Myrick Park		90	50	69	100	100	54	100	60	73
3 Forest Hills Golf Course (ON TOP OF HILL)		85	20	83	50	100	96	100	100	75
4 Forest Hills Golf Course (BY THE ROAD)		90	80	89	100	100	96	100	100	93
5 Bluffview Park		80	70	81	50	100	91	60	70	73
6 Weigent Park		100	80	81	80	100	68	70	80	80
7 Roellig Park		90	80	61	100	100	71	100	100	86

Results:

- #1 Forest Hills, lower site
- #2 Roellig Park
- #3 Weigent Park
- #4 Memorial Pool Location



Site Selection Conclusions

The committee should consider the following sites:

#1 Forest Hills, lower site

#2 Roellig Park

~~#3 Weigent Park~~

#4 Memorial Pool Location

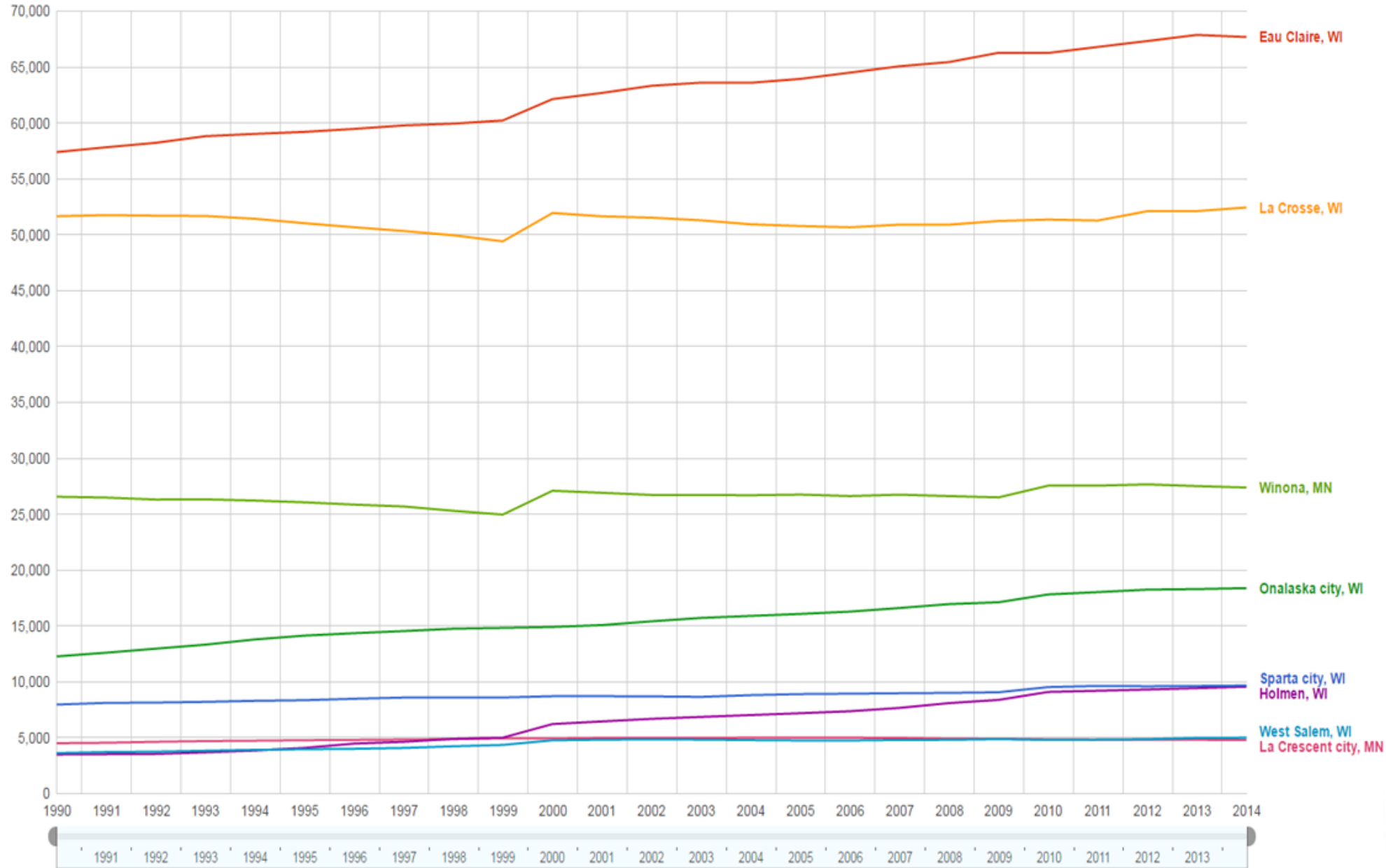

Service Area Demographics

Year	2017	2042
Resident Population of La Crosse	52,440	53,637
Nonresident Service Area Population	42,000	43,109
Proposed Facility Total Service Population	94,400	96,746

*La Crosse Metro Area Population 133,665

**La Crosse County Population 114,665

BURBACH AQUATICS, INC.
ARCHITECTS & ENGINEERS

Your Quality Choice for Aquatic Design !

www.burbachaquatics.com | baee@centurytel.net

Population in 2014: 52,440 (100% urban, 0% rural). Population change since 2000: +1.2%



Males: 25,353 (48.3%)

Females: 27,087 (51.7%)

Median resident age: 29.1 years

Wisconsin median age: 39.0 years

Zip codes: [54601](#).

Estimated median household income in 2013: \$40,624 (it was \$31,103 in 2000)

La Crosse: \$40,624

WI: \$51,467

Estimated per capita income in 2013: \$21,115 (it was \$17,650 in 2000)

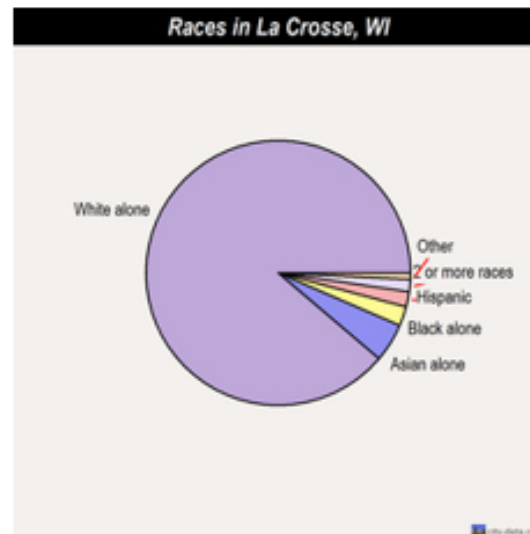

BURBACH AQUATICS, INC.
ARCHITECTS & ENGINEERS

Your Quality Choice for Aquatic Design!

www.burbachaquatics.com | baee@centurytel.net

Local Temperature Conditions

Month	High	Low
January	26	9
February	31	14
March	44	25
April	59	38
May	71	49
June	80	58
July	84	63
August	82	61
September	73	52
October	60	40
November	44	28
December	29	14

*Climate Data derived from 1981 – 2010 normals.

Seasonal Temperature Data and Precipitation

Month	Average # of Days with Temperatures Greater than 90	Average # of Days with Precipitation Greater than 0.10"	Average Monthly Precipitation (inches)
January	0	8	1.1
February	0	5	1.06
March	0	6	2.05
April	0	3	3.35
May	0	8	3.5
June	5	9	4.33
July	5	7	4.25
August	3	7	4.29
September	0	10	3.54
October	0	6	2.17
November	0	9	2.01
December	0	9	1.38
Average Annual Precipitation (in.) 33.03			
*Climate Data derived from 1981 – 2010 normals.			

BURBACH AQUATICS, INC.
ARCHITECTS & ENGINEERS

Your Quality Choice for Aquatic Design!

Was 2016 attendance due to weather or closing of Memorial

Criteria	Weather Data					
	Year					
	2011	2012	2013	2014	2015	2016
Days warmer than 80 degrees	65	74	61	61	58	71
Days Above 90 degrees	13	29	14	1	7	11
Rain Days greater than 0.2"	16	7	12	21	13	20
Days warmer than 80 with rain	7	7	6	15	8	16
Total Swim Days	58	67	55	46	50	55
Attendance Per Day	805	812	735	773	808	652

- Weather patterns in 2016 suggest attendance similar to 2011, 2013 and 2015.
- Actual attendance dropped.
- Data suggests people went elsewhere or didn't swim.

Area Competing Facilities

Name of Pool	Location	Distance from La Crosse	Population	Size of pool	Type of Pool	Zero Depth	Waterslide	Diving	Swim Lanes	Other
Erickson Pool	2412 Losey Blvd. St. La Crosse, WI	0		10,200	Multi-use	Y	Y-2	Y	Y-4(25 yard)	Drop Slide
North Side Community	806 Sill St. La Crosse, WI	0		9,000	Multi-use	Y	Y-1	Y	N (but possible 25 yard)	
Logan HighSchool Swimming Pool	1500 Ranger Dr. La Crosse, WI	0		4,000	Indoor	N		Y	Y-6(25 yard)	
UWL-Mitchel Hall	1725 State St. La Crosse, WI	0		4,000	Indoor	N	N	N	Y-6(25 meter)	
La Crosse YMCA	1140 Main St. La Crosse, WI	0	52,440	3,150	Indoor	N	N	N	Y-6(25 yard)	
Onalaska Aquatic Center	251 Riders Club Road, Onalaska, WI	6	17,736	8,500	Multi-use	Y	Y-2 (run-out)	Y	Y-6(25 yard)	Drop Slide
Onalaska YMCA	400 Mason St. Onalaska, WI	6		3,250	Indoor	Y	Y	Y	Y-6(25 yard)	
La Crescent Aquatic Center	608 S. Seventh St., La Crescent, MN	6	4,810	8,500	Multi-use	Y	Y-2	Y	Y-6(25 yard)	
Hokah Swimming Pool	20 Como St., Hokah, MN	10	567	18,000	Multi-use	N	N	Y	N	Sand Beach
John W.Chapman Aquatic Center	315 Anderson St., Holmen, WI	12	9,423	11,500	Multi-use	Y	Y-1	Y	Y-6(25 yard)	Sand Play Area/Dropslide
Swarthout Pool	West Salem	13	4,980	4,000	Box-type	N	N	Y	Y-6(25 yard)	Wading Pool (400 sq.ft.)
Trenpealeau Municipal Pool	23976 Forth St., Trenpealeau, WI	24	1,611	4,300	Box-type	N	N	Y	Y-6(25 meter)	Deck Slide
Westby Municipal Pool	Market St., Westby, WI	26	2,255	4,800	Box-type	N	N	N	N	
Galesville Municipal Pool	17511 N. Main St. Galesville, WI	26	1,556	3,000	Box-type	N	N	Y	N	
Sparta Family Aquatic Cener	Rusk Avenue, Sparta, WI	29	9,522	15,665	Multi-Use (RAC)	Y	Y-2	Y	Y-6(50 meter)	Lazy River /Water Walk
Melrose Area Swimming Pool	802 Third St. Melrose, WI	31	503	3,300	Box-type	N	N	Y	N	
Bob Welch Aquatic Center	708 W. Fourth St., Winona, MN	32	27,546	18,400	Multi-use	Y	Y-1	Y	Y-8(50 Meter & 25 Yards)	
Spring Grove SWIM Center	600 Maple Drive, Spring Grove, MN	33	1,307	6,000	Multi-use	Y	Y-2	Y	Y-5(25 yard)	2 Drop Slides/ Waterwalk
Lansing Pool	490 Bench St., Lansing, IA	34	963	3,200	Box-type	N	N	Y	N	
Arcadia Family Aquatic Center	415 Gavney Road, Arcadia, WI	44	2,925	6,300	Multi-use	Y	Y	Y	Y	
Tomah Aquatic Center	411 E. Holton St., Tomah, WI	45	9,093	10,025	Multi-use	Y	Y-2	Y	Y-6(25 meter)	Drop Slide
Lunda Center	405 WI-54 Black River Falls, WI	46	3,613	8,800	Indoor	Y	Y	Y	Y	
Hoffman Aquatic Park	1400 Tyler St. Black River Falls, WI	46		10,100	Multi-use	Y	Y-2	N	N	2-Drop Slides/Sand Play Area
Wilton Pool	300 East St., Wilton, WI	46	502	3,150	Box-type	N	N	N	Y-6(25 yard)	
Scenic Valley Swimming Pool	Goose Lake Park, Cochrane, WI	48	438	3,275	Box-type	N	N	Y	Y	Wading Pool (200 sq.ft.)
Whitehall Aquatic Center	36522 West St., Whitehall, WI	50	1,584	5,900	Multi-use	Y	Y-1	Y	Y-5(25 meter)	Drop Slide
Gays Mills Swimming Pool	346 S. Railroad St., Gays Mills, WI	51	533	3,450	Box-type	N	N	Y	Y-5(25 meter)	
Charles Wacouta Aquatic Park	1401 E. Wells St., Praire Du Chien, WI	59	5,911	12,000	Multi-use	Y	Y-1	Y	Y-7(25 yard)	Spray pad

Memorial Municipal Pool

0

9900

N

N

Y

Possible but not reg.

Black River Beach (Guarded)

200,000

Pettibone Beach (Guarded)

200,000

North Pettibone

Therapy Pools in area

Springbrook

BURBACH AQUATICS, INC.
ARCHITECTS & ENGINEERS

Your Quality Choice for Aquatic Design !

BAI also reviewed the four areas of swimming with the La Crosse Pool Committee, which are:

- Recreation
- Education
- Health and Wellness
- Competition

La Crosse Parks and Recreation staff gave a presentation on the programming offered by the City of La Crosse and BAI did a review of the different programming elements offered within the service area. Two areas identified as a potential gaps were lap/competitive swimming areas and availability of therapy pool areas for rehabilitation purposes.





Erickson Pool- La Crosse, WI



North Side Community Pool - La Crosse, WI

BURBACH AQUATICS, INC.
ARCHITECTS & ENGINEERS

Your Quality Choice for Aquatic Design !

www.burbachaquatics.com | baae@centurytel.net

Existing Facilities Analysis

- Northside:
 - Large Zero-depth
 - Small amount of 2' to 4' water depth
 - Space limitations for expansion
- Erickson:
 - Large Zero-depth
 - Potential space for 8-lane, 25 yard pool to be added,
 - Green space makes Erickson attractive
 - Bathhouse/Mechanical System size would likely not accommodate addition
 - Operational Cost for an expansion would be less than 3rd outdoor





Onalaska Aquatic Center- Onalaska, WI



La Crescent Aquatic Centre- La Crescent, MN

BURBACH AQUATICS, INC.
ARCHITECTS & ENGINEERS

Your Quality Choice for Aquatic Design !

www.burbachaquatics.com | bae@centurytel.net



John W. Chapman Aquatic Center- Holmen, WI



Hokah Swimming Pool- Hokah, MN

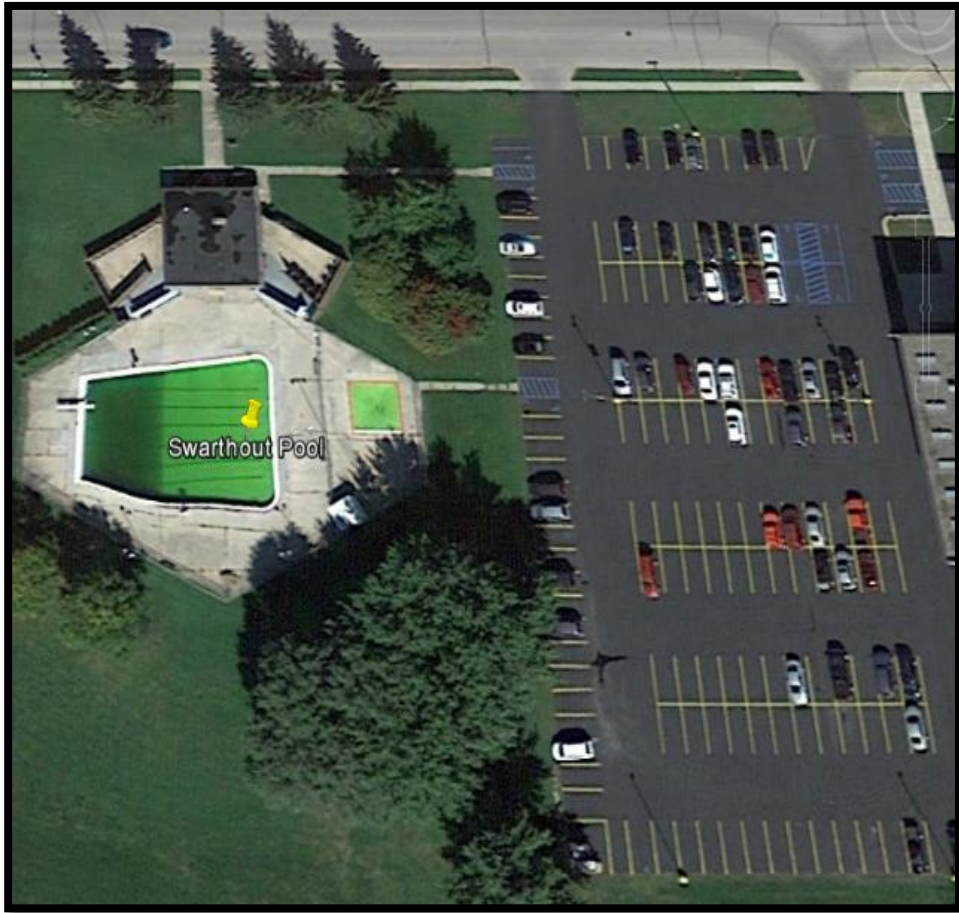

Swarthout Pool-West Salem, WI



Trempealeau Municipal Pool- Trempealeau, WI



Westby Municipal Pool-Westby, WI



Galesville Swimming pool

Galesville Swimming Pool- Galesville, WI



Sparta Family Aquatic Center- Sparta, WI

BURBACH AQUATICS, INC.
ARCHITECTS & ENGINEERS

Your Quality Choice for Aquatic Design !

www.burbachaquatics.com | baae@centurytel.net

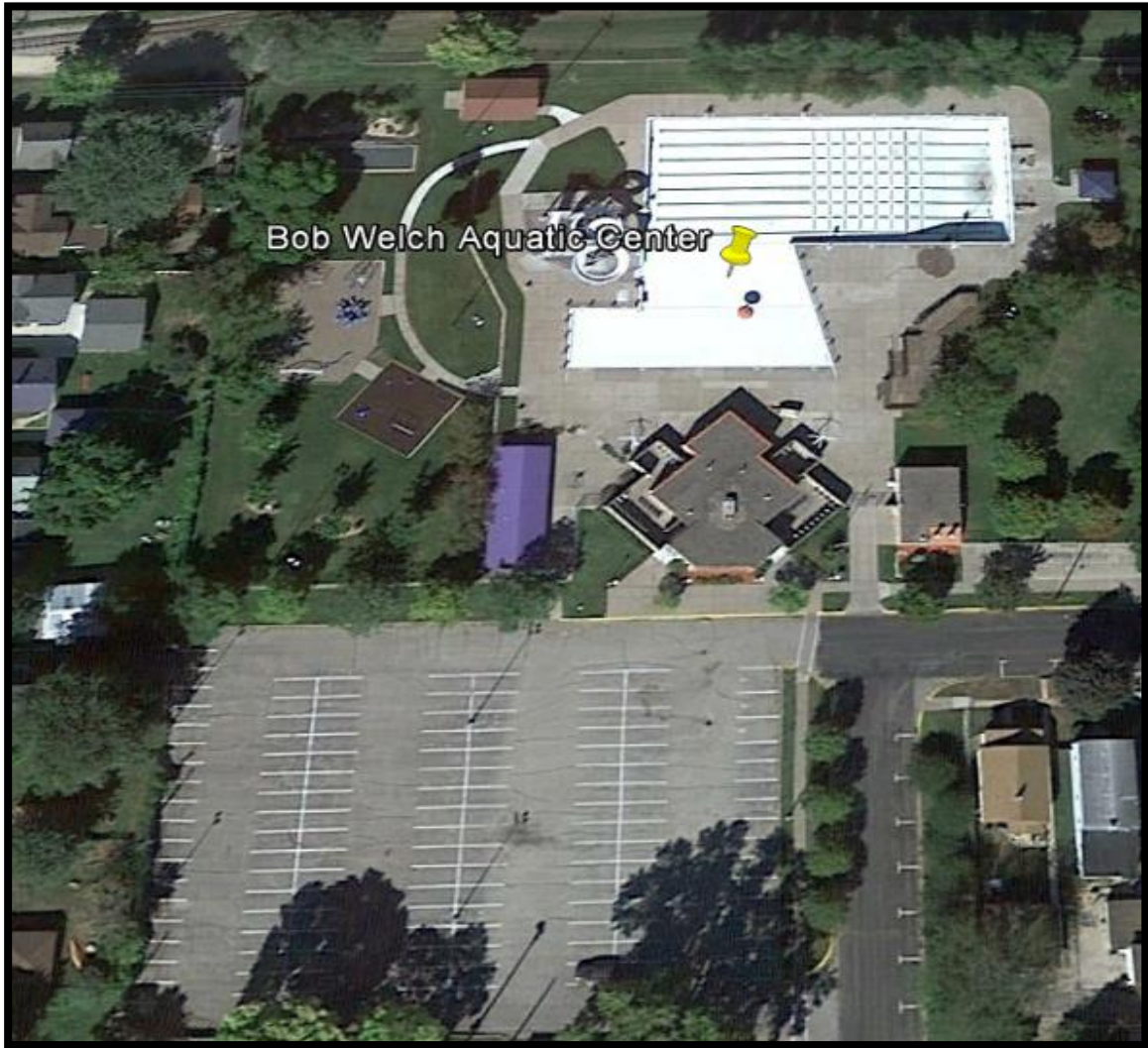

Bob Welch Aquatic Center- Winona, MN



Melrose Area Swimming Pool- Melrose, WI

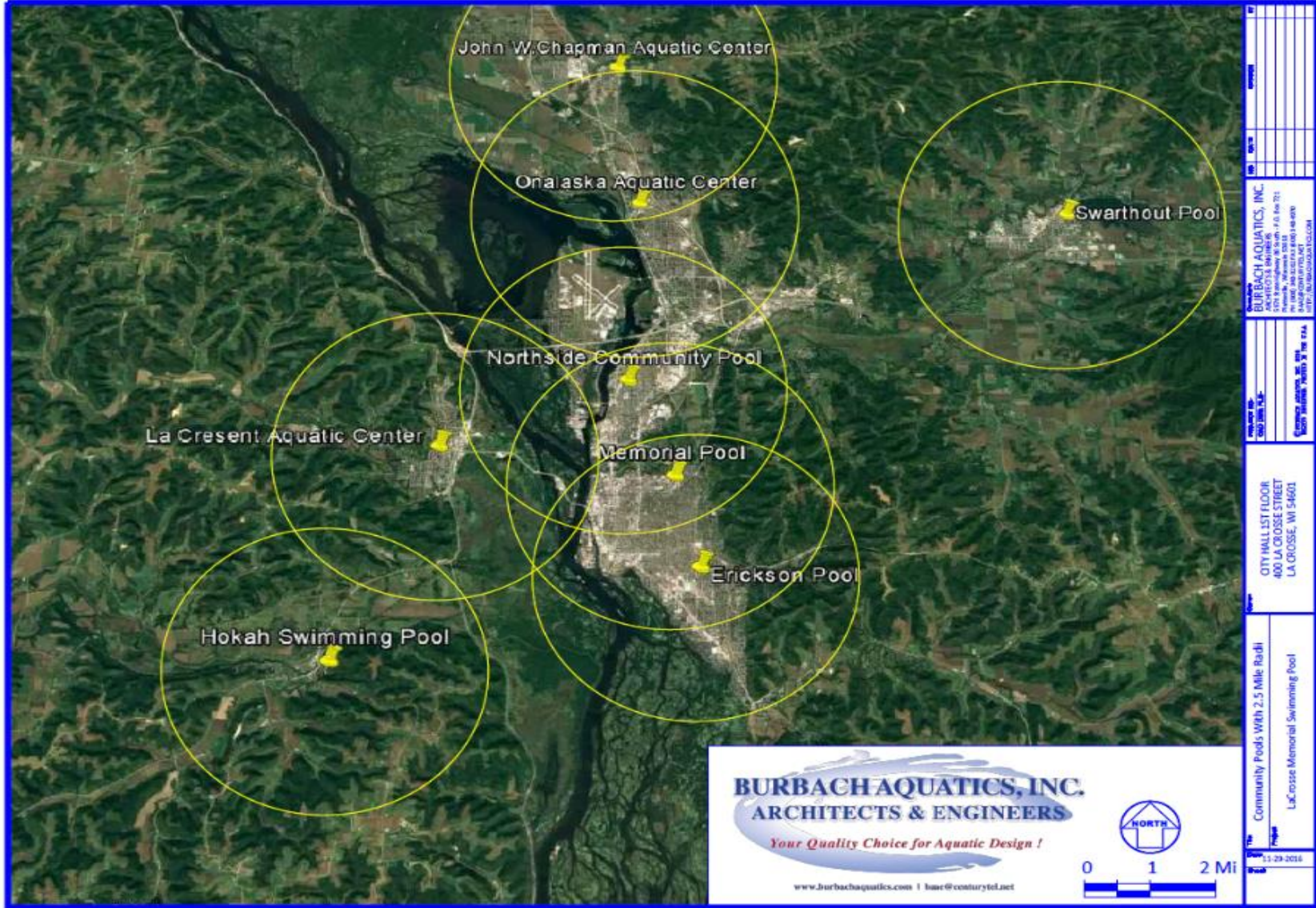

BURBACH AQUATICS, INC.
ARCHITECTS & ENGINEERS

Your Quality Choice for Aquatic Design !

www.burbachaquatics.com | baac@centurytel.net



Project	Community Pools With 5 Mile Radii
Client	City of La Crosse
Location	La Crosse, WI
Date	11-29-2016
Scale	1" = 5 Miles
Author	
Checked	
Approved	
Discussed	
Reviewed	
Final	

BURBACH AQUATICS, INC.
 ARCHITECTS & ENGINEERS
 1000 W. MONROE ST. SUITE 100 - 100 W. 100
 PO BOX 400000 LA CROSSE WISCONSIN
 CITY OF LA CROSSE, WISCONSIN

Community Pools With 5 Mile Radii
 LaCrosse Memorial Swimming Pool

BURBACH AQUATICS, INC.
ARCHITECTS & ENGINEERS

Your Quality Choice for Aquatic Design!

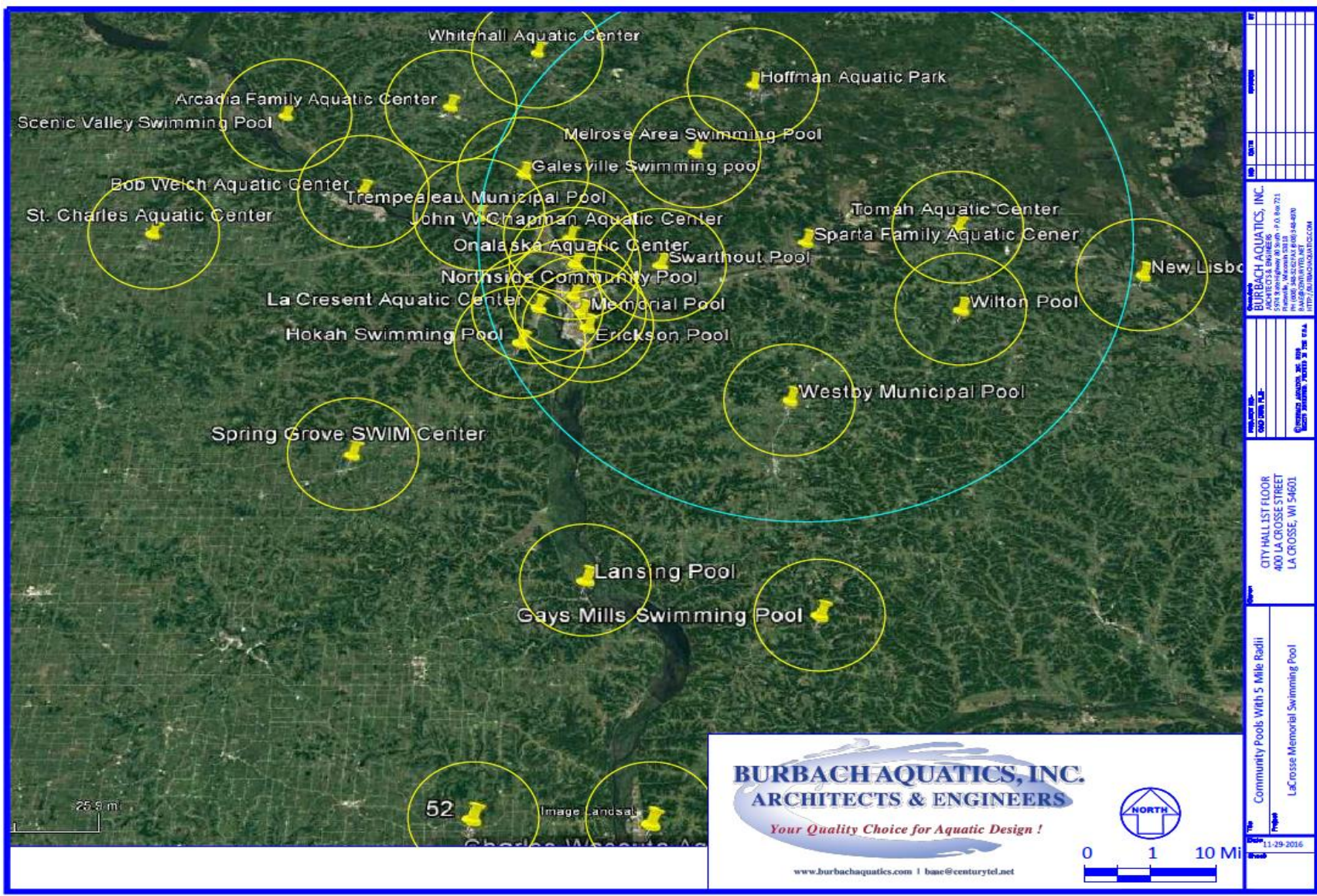

<p>BURBACH AQUATICS, INC. ARCHITECTS & ENGINEERS 400 LA CROSSE STREET LA CROSSE, WISCONSIN 54601 PH: (608) 785-8200 FAX: (608) 785-4470 WWW.BURBACHAQUATICS.COM</p>
<p>PROJECT NO. _____ DATE _____ CLIENT _____ COUNTY _____ CITY _____</p>
<p>CITY HALL 1ST FLOOR 400 LA CROSSE STREET LA CROSSE, WI 54601</p>
<p>Community Pools With 5 Mile Radii LaCrosse Memorial Swimming Pool</p>
<p>DATE: 11-29-2016</p>

BURBACH AQUATICS, INC.
ARCHITECTS & ENGINEERS
Your Quality Choice for Aquatic Design !
 www.burbachaquatics.com | baec@centurytel.net

0 1 10 Miles

BURBACH AQUATICS, INC.
ARCHITECTS & ENGINEERS
Your Quality Choice for Aquatic Design !
 www.burbachaquatics.com | baec@centurytel.net

Outdoor Recreational Natant Demand For 2017

Approximate Water Area Required

Approximate City Population	=	52,440 ¹
College population adjustment	=	-(9,000)
Surrounding Population Contribution	=	43,075 ¹
Total Service Population	=	86,515
Peak Swimming Attendance (5% of total)	=	4,325
Pool Vessel Capacity (85% of Peak Attendance)	=	3,676
Total Approximate Water Area @ 15 Sq. Ft. per user	=	54,140

From this total water surface area for recreational swimming in the community, the surface areas of competing facilities, public and private, must be deducted.

Area Facilities	Water Area (Sq. Ft.)	Utilization ² Factor	Usage Value (Sq. Ft.)
Erickson Pool	10,200	100%	10,200
North Side Community Pool	9,000	100%	9000
Onalaska Aquatic Center	8,500	80%	6800
La Crescent Aquatic Center	8,500	50%	4250
**La Crosse Beaches	*	0%	15,000
John W. Chapman Aquatic Center	11,500	10%	1150
Swathout Pool	4,000	0%	0
Total Recreation Water Service Currently Available			46,400
Total Recreation Water Area Required			= 54,140 Sq. Ft.
Less Total Recreation Water Provided			= 46,400 Sq. Ft.
Adjusted Recreation Water Area Required			= 8,740 Sq. Ft.



Regional Recreational Natant Demand For 2017

Approximate Water Area Required

Approximate City Population	=	52,440 ¹
College population adjustment	=	-(9,000)
Surrounding Population Contribution (La Crosse Metro Area)	=	90,225 ¹
Total Service Population	=	133,665
Peak Swimming Attendance (2% of total)	=	2,673
Pool Vessel Capacity (85% of Peak Attendance)	=	2,272
Total Approximate Water Area @ 15 Sq. Ft. per user	=	34,080

From this total water surface area for recreational swimming in the community, the surface areas of competing facilities, public and private, must be deducted.

Area Facilities	Water Area (Sq. Ft.)	Utilization ² Factor	Usage Value (Sq. Ft.)
Erickson Pool	10,200	40%	4,080
North Side Community Pool	9,000	40%	3,600
Onalaska Aquatic Center	8,500	5%	425
La Crescent Aquatic Center	8,500	2%	170
**La Crosse Beaches	*	0%	30,000
John W. Chapman Aquatic Center	11,500	2%	230
Sparta Family Aquatic Center	15,655	50%	7,828
Bob Welch Aquatic Center	18,400	1%	184
Total Recreation Water Service Currently Available			46,517
Total Recreation Water Area Required	=		34,808 Sq.Ft.
Less Total Recreation Water Provided	=		46,517 Sq. Ft.
Adjusted Recreation Water Area Required	=		(12,437) Sq. Ft.

BURBACH AQUATICS, INC.
ARCHITECTS & ENGINEERS

Your Quality Choice for Aquatic Design !

Indoor Recreational Natant Demand For 2017

Approximate Water Area Required

Approximate City Population	=	52,440 ¹
College population adjustment	=	0
Surrounding Population Contribution	=	43,075 ¹
Total Service Population	=	95,515
Peak Swimming Attendance (0.5% of total)	=	478
Pool Vessel Capacity (85% of Peak Attendance)	=	406
Total Approximate Water Area @ 15 Sq. Ft. per user	=	6,089

From this total water surface area for recreational swimming in the community, the surface areas of competing facilities, public and private, must be deducted.

<u>Area Facilities</u>	<u>Water Area (Sq. Ft.)</u>	<u>Utilization² Factor</u>	<u>Usage Value (Sq. Ft.)</u>
Logan High School Swimming Pool	4,000	2%	80
UWL-Mitchell Hall	4,000	2%	80
La Crosse YMCA	3,150	30%	945
Onalaska YMCA	3,250	2%	65
Lunda Center	8,800	0%	0
Total Recreation Water Service Currently Available			1,170

Total Recreation Water Area Required	=	6,089 Sq. Ft.
Less Total Recreation Water Provided	=	1,170 Sq. Ft.
Adjusted Recreation Water Area Required	=	4,919 Sq. Ft.



Review of Natant Demand Compared to Existing Attendance Data

Pool Participation Numbers	2011	2012	2013	2014	2015	2016
Erickson Pool	26,702	28,070	22,926	20,499	24,172	26,802
Memorial Pool	6,042	14,267	8,280	5,463	5,864	0
Northside Pool	13,963	12,099	9,231	9,592	10,345	9,070
TOTAL	46,707	54,436	40,437	35,554	40,381	35,872

- Peak yearly attendance of 55,000 per year
- 55 days per year, weather dependent
- Average 860 swimmers per day

Average and Peak Pool Sizing

Average Attendance

Average Daily Attendance	860 people
Pool size (Ave. Attendance X 15 s.f.)	12,900 s.f.
Existing Pools Size Provided	19,200 s.f.
Surplus for Average Daily Attendance	6,300 s.f.

Peak Attendance

Peak Daily Attendance (Daily X 2)	1,720 people
Peak Pool Size	25,800 s.f.
Erickson	10,000 s.f.
Northside	9,000 s.f.
Additional Peak Demand	6,800 s.f.

Peak Pool Sizing

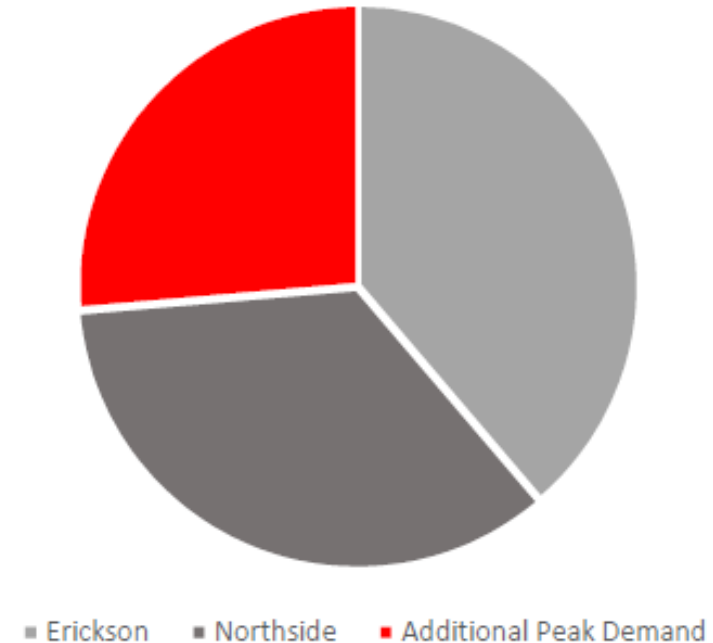

- BAI's original natant demand analysis shows a shortfall of 8,740 square feet of water surface area.

Opinion of Construction Costs- Conceptual Site Plans	
Version #1- (With Lazy River)- Existing Memorial Site	\$4,900,000
Version #1- (Without Lazy River)- Existing Memorial Site	\$4,000,000
Version #2- Existing Memorial Site	\$3,900,000
Version #3- (With Lazy River)- Forest Hills Lower Site	\$4,700,000
Version #3- (Without Lazy River)- Forest Hills Lower Site	\$3,800,000
Version #4- Indoor Pool Option- St. Andrews (Trane Site)	\$12,000,000
Version #5- Erickson Pool Expansion	\$1,489,000
Version #6- (With Lazy River)- Existing Memorial Site	\$4,920,000
Version #6- (Without Lazy River)- Existing Memorial Site	\$4,020,000
Version #7- Existing Memorial Site	\$3,950,000
Version #7- Existing Memorial Site	\$4,025,000
Version #8- (With Vortex Pool)- Forest Hills Lower Site	\$4,070,000
Version #8- (Without Vortex Pool)- Forest Hills Lower Site	\$3,820,000
Version #9- Indoor Pool Option- St. Andrews (Trane Site)	\$14,500,000
Version #10- Existing Memorial Site	\$3,955,000
Version #11- Indoor Pool Option- St. Andrews (Trane Site)	\$12,500,000



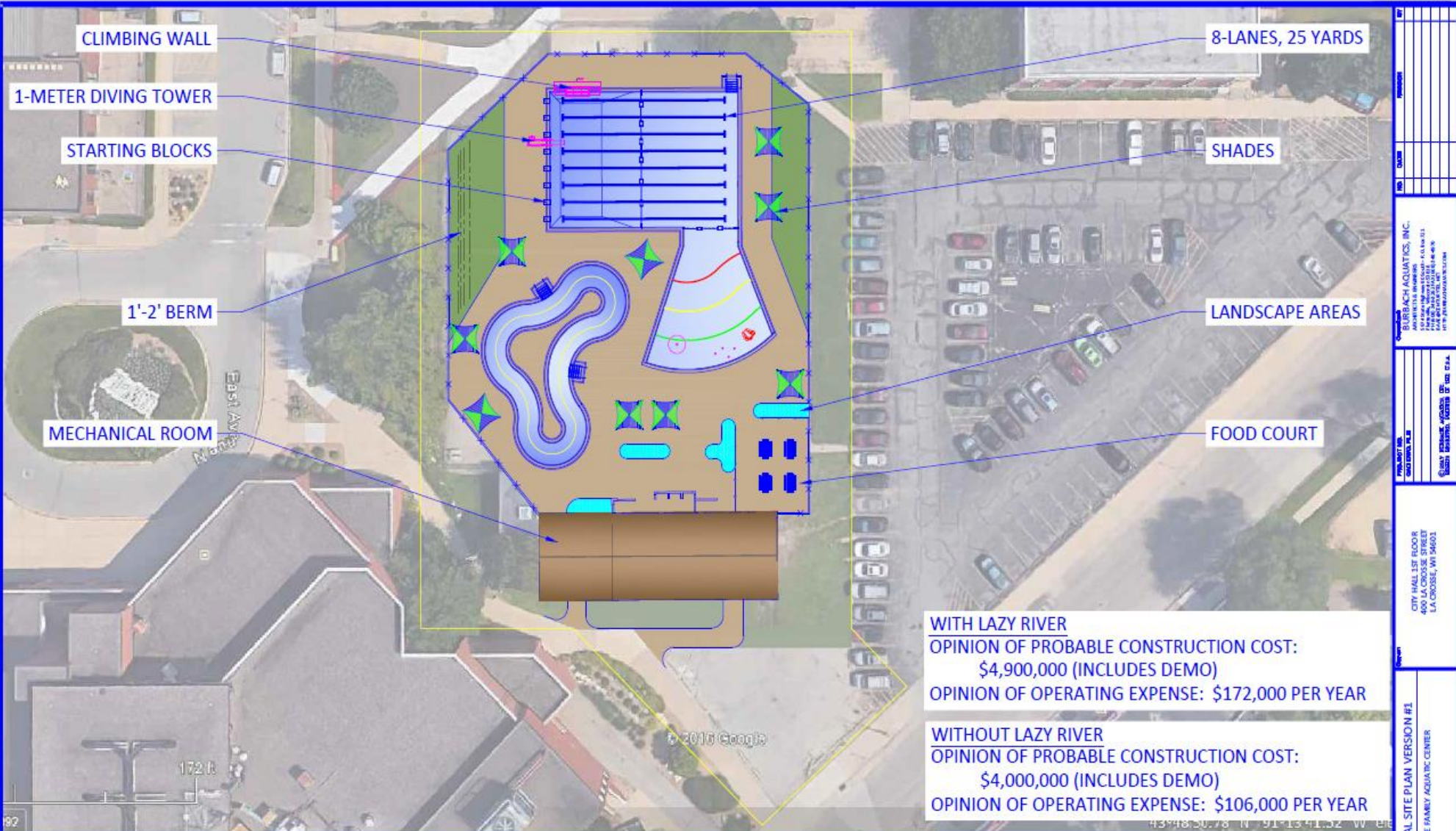

8-LANES, 25 YARDS

SHADES

LANDSCAPE AREAS

FOOD COURT

CLIMBING WALL

1-METER DIVING TOWER

STARTING BLOCKS

1'-2' BERM

MECHANICAL ROOM

WITH LAZY RIVER
 OPINION OF PROBABLE CONSTRUCTION COST:
 \$4,900,000 (INCLUDES DEMO)
 OPINION OF OPERATING EXPENSE: \$172,000 PER YEAR

WITHOUT LAZY RIVER
 OPINION OF PROBABLE CONSTRUCTION COST:
 \$4,000,000 (INCLUDES DEMO)
 OPINION OF OPERATING EXPENSE: \$106,000 PER YEAR

VERSION #1 - CONCEPTUAL SITE PLAN STATISTICS	
BATHHOUSE AREA	3,743 SQ. FT.
MAIN POOL SURFACE AREA	6,743 SQ. FT.
LAZY RIVER SURFACE AREA	1,933 SQ. FT.
POOL PATRON CAPACITY	516 PATRONS

VERSION #1 - WATER DEPTH BREAKDOWN		
0 - 2'	1,206 SQ. FT.	14%
2' - 4'	2,641 SQ. FT.	31%
LAZY RIVER AREA	1,933 SQ. FT.	22%
4' +	2,896 SQ. FT.	33%

BURBACH AQUATICS, INC.
 ARCHITECTS & ENGINEERS
Your Quality choice for Aquatic Design!
 WWW.BURBACHAQUATICS.COM
 BAAE@CENTURYTEL.NET

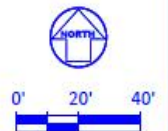

PROJECT INFORMATION

NO.	DATE	DESCRIPTION

DESIGNER
 BURBACH AQUATICS, INC.
 ARCHITECTS & ENGINEERS
 400 LA CROSSE STREET
 LA CROSSE, WI 54601
 WWW.BURBACHAQUATICS.COM

PREPARED BY
 BURBACH AQUATICS, INC.
 ARCHITECTS & ENGINEERS
 400 LA CROSSE STREET
 LA CROSSE, WI 54601
 WWW.BURBACHAQUATICS.COM

PROJECT NAME
 CONCEPTUAL SITE PLAN VERSION #1
 LA CROSSE FAMILY AQUATIC CENTER

DATE
 2-7-2017

PROJECT NUMBER
 PH1-S2

BURBACH AQUATICS, INC.
 ARCHITECTS & ENGINEERS
Your Quality Choice for Aquatic Design!

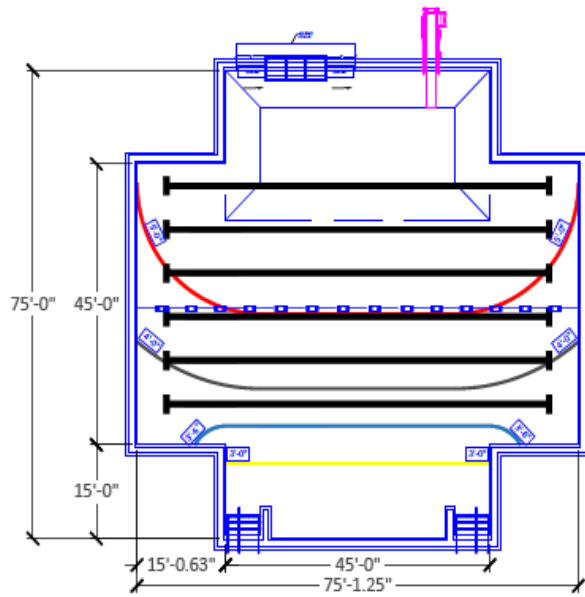

GENA PROPOSED
DIMENSIONS
4,705
SQ. FT.

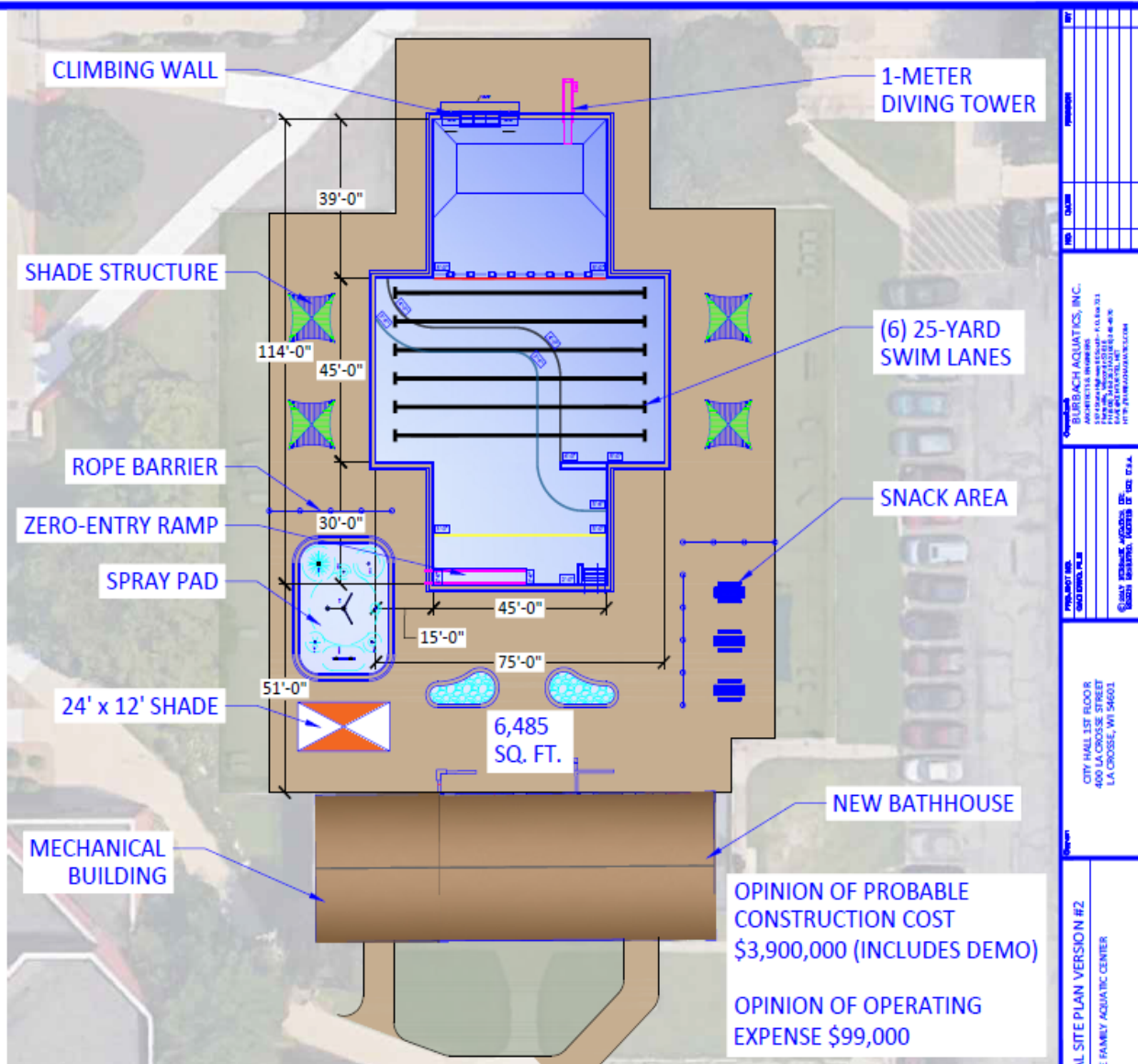

OPINION OF PROBABLE
CONSTRUCTION COST
\$3,900,000 (INCLUDES DEMO)

OPINION OF OPERATING
EXPENSE \$99,000

VERSION #2 - CONCEPTUAL SITE PLAN STATISTICS

BATHHOUSE AREA	3,743 SQ. FT.
MAIN POOL SURFACE AREA	6,485 SQ. FT.
SPRAY PAD SURFACE AREA	715 SQ. FT.
POOL PATRON CAPACITY	432 PATRONS

VERSION #2 - WATER DEPTH BREAKDOWN

SPRAY PAD AREA	715 SQ. FT.	10%
	0 - 2'	0%
	2' - 4'	41%
	4' +	49%
	2,972 SQ. FT.	
	3,513 SQ. FT.	

BURBACH AQUATICS, INC.
ARCHITECTS & ENGINEERS

"Your Quality choice for Aquatic Design!"
WWW.BURBACHAQUATICS.COM
BAAE@CENTURYTEL.NET



CONCEPTUAL SITE PLAN VERSION #2

LACRO-SEE FAMILY AQUATIC CENTER

Date 3-29-2017

PH1-S2

BURBACH AQUATICS, INC.
ARCHITECTS & ENGINEERS
1800 W. STATE ST. SUITE 1000
LA CROSSE, WI 54601
TEL: 608.785.4444
WWW.BURBACHAQUATICS.COM

CITY HALL 1ST FLOOR
400 LA CROSSE STREET
LA CROSSE, WI 54601

BURBACH AQUATICS, INC.
ARCHITECTS & ENGINEERS

Your Quality Choice for Aquatic Design!

LAZY RIVER
 1-METER DIVING TOWER
 CLIMBING WALL
 (8) 25-YARD SWIM LANES

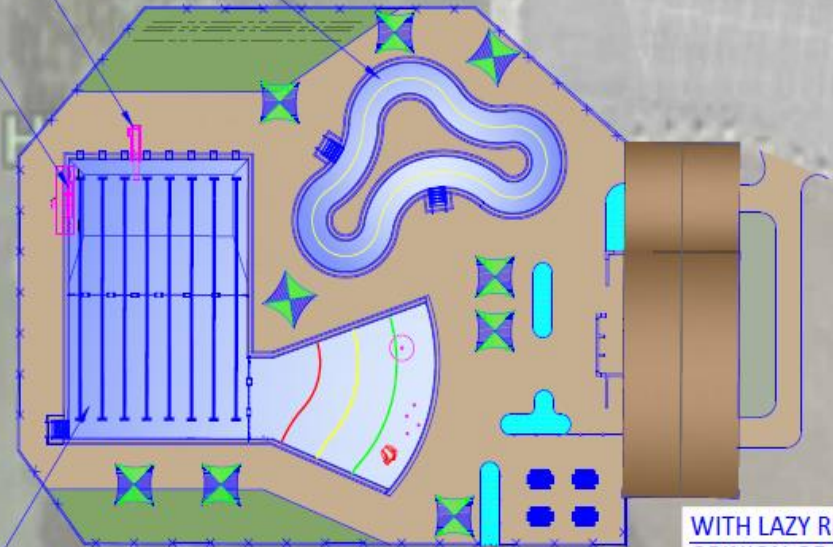

WITH LAZY RIVER
 OPINION OF PROBABLE CONSTRUCTION COST:
 \$4,700,000
 OPINION OF OPERATING EXPENSE: \$172,000 PER YEAR

WITHOUT LAZY RIVER
 OPINION OF PROBABLE CONSTRUCTION COST:
 \$3,800,000
 OPINION OF OPERATING EXPENSE: \$106,000 PER YEAR

VERSION #3 CONCEPTUAL SITE PLAN STATISTICS	
BATHHOUSE AREA	3,743 SQ. FT.
MAIN POOL SURFACE AREA	6,743 SQ. FT.
LAZY RIVER SURFACE AREA	1,933 SQ. FT.
POOL PATRON CAPACITY	516 PATRONS

VERSION #3 - WATER DEPTH BREAKDOWN		
0 - 2'	1,206 SQ. FT.	14%
2' - 4'	2,641 SQ. FT.	31%
LAZY RIVER AREA	1,933 SQ. FT.	22%
4' +	2,896 SQ. FT.	33%

BURBACH AQUATICS, INC.
 ARCHITECTS & ENGINEERS
 "Your Quality choice for Aquatic Design!"
 WWW.BURBACHAQUATICS.COM
 BAAD@CENTURYTEL.NET



PROJECT NO.	PHI-52
DATE	9-29-2017
PROJECT	CONCEPTUAL SITE PLAN VERSION #3 LACROSSE FAMILY AQUATIC CENTER
CLIENT	CITY HALL 1ST FLOOR 400 LA CROSSE STREET LA CROSSE, WI 54601
DESIGNER	BURBACH AQUATICS, INC. ARCHITECTS & ENGINEERS 100 WISCONSIN STREET LA CROSSE, WI 54601 WWW.BURBACHAQUATICS.COM BAAD@CENTURYTEL.NET
SCALE	AS SHOWN
DATE	
BY	

BURBACH AQUATICS, INC.
 ARCHITECTS & ENGINEERS
 Your Quality Choice for Aquatic Design!

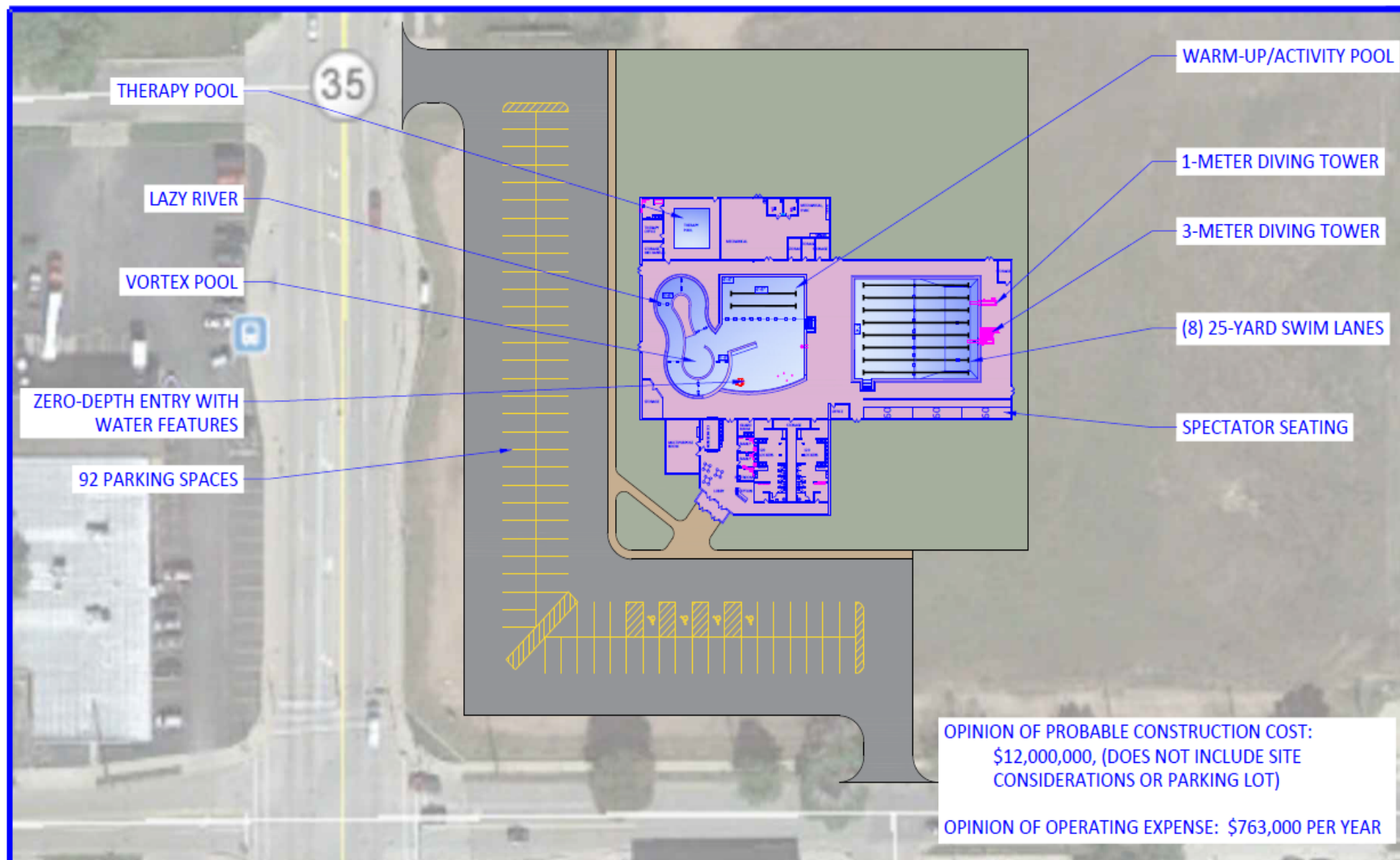

PROJECT NO.	17-001
DATE	3-29-2017
PROJECT NAME	LACROSSE FAMILY AQUATIC CENTER
CLIENT	CITY OF LACROSSE, WISCONSIN
ARCHITECT	BURBACH AQUATICS, INC.
ADDRESS	400 LA CROSSE STREET LACROSSE, WI 54601
PHONE	920.735.1111
WEBSITE	WWW.BURBACHAQUATICS.COM
PROJECT FILE	LA CROSSE AQUATIC CENTER
CONCEPTUAL SITE PLAN VERSION #4	
PHI-S2	

VERSION #4 CONCEPTUAL SITE PLAN STATISTICS	
BATHHOUSE AREA	6,930 SQ. FT.
NATATORIUM AREA	20,465 SQ. FT.
MULTIPURPOSE ADDITION AREA	600 SQ. FT.
THERAPY ADDITION AREA	1,691 SQ. FT.
TOTAL BUILDING AREA	29,686 SQ. FT.

VERSION #4 CONCEPTUAL SITE PLAN STATISTICS	
LAZY RIVER LENGTH	150 LN. FT.
COMPETITION POOL SURFACE AREA	4,202 SQ. FT.
RECREATION POOL SURFACE AREA	4,740 SQ. FT.
THERAPY POOL SURFACE AREA	530 SQ. FT.
TOTAL WATER SURFACE AREA	9,472 SQ. FT.

BURBACH AQUATICS, INC.
ARCHITECTS & ENGINEERS

"Your Quality choice for Aquatic Design!"
WWW.BURBACHAQUATICS.COM
BAAE@CENTURYTEL.NET



BURBACH AQUATICS, INC.
ARCHITECTS & ENGINEERS

Your Quality Choice for Aquatic Design!

www.burbachaquatics.com | baae@centurytel.net



ADD (4) 25-YARD SWIM LANES

ADDITIONAL DECK SPACE

OPINION OF PROBABLE CONSTRUCTION COST
\$1,489,000
ADDITIONAL OPERATING COST: \$12,000

*REQUIRES FURTHER INVESTIGATION OF MECHANICAL CAPACITY AND BATHHOUSE FIXTURE REQUIREMENTS

NO.	REVISION

BURBACH AQUATICS, INC. ARCHITECTS & ENGINEERS <small>5500 W. BROADWAY SUITE 100 LACROSSE, WI 54601 (608) 785-9510 WWW.BURBACHAQUATICS.COM</small>	
PROPERTY NO. <small>LA CROSS FLS</small>	PROJECT NO. <small>PH1-S2</small>
CITY HALL 1ST FLOOR 400 LA CROSSE STREET LA CROSSE, WI 54601	
CONCEPTUAL SITE PLAN VERSION #5 <small>LACROSSE FAMILY AQUATIC CENTER</small>	
<small>3-19-2017</small>	

VERSION #5 CONCEPTUAL SITE PLAN STATISTICS

ADDITIONAL POOL SURFACE AREA	2,100 SQ. FT.
ADDITIONAL DECK AREA	2,640 SQ. FT.

BURBACH AQUATICS, INC.
ARCHITECTS & ENGINEERS

"Your Quality choice for Aquatic Design!"

WWW.BURBACHAQUATICS.COM
BAAE@CENTURYTEL.NET

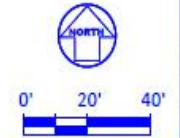

BURBACH AQUATICS, INC.
ARCHITECTS & ENGINEERS

Your Quality Choice for Aquatic Design!

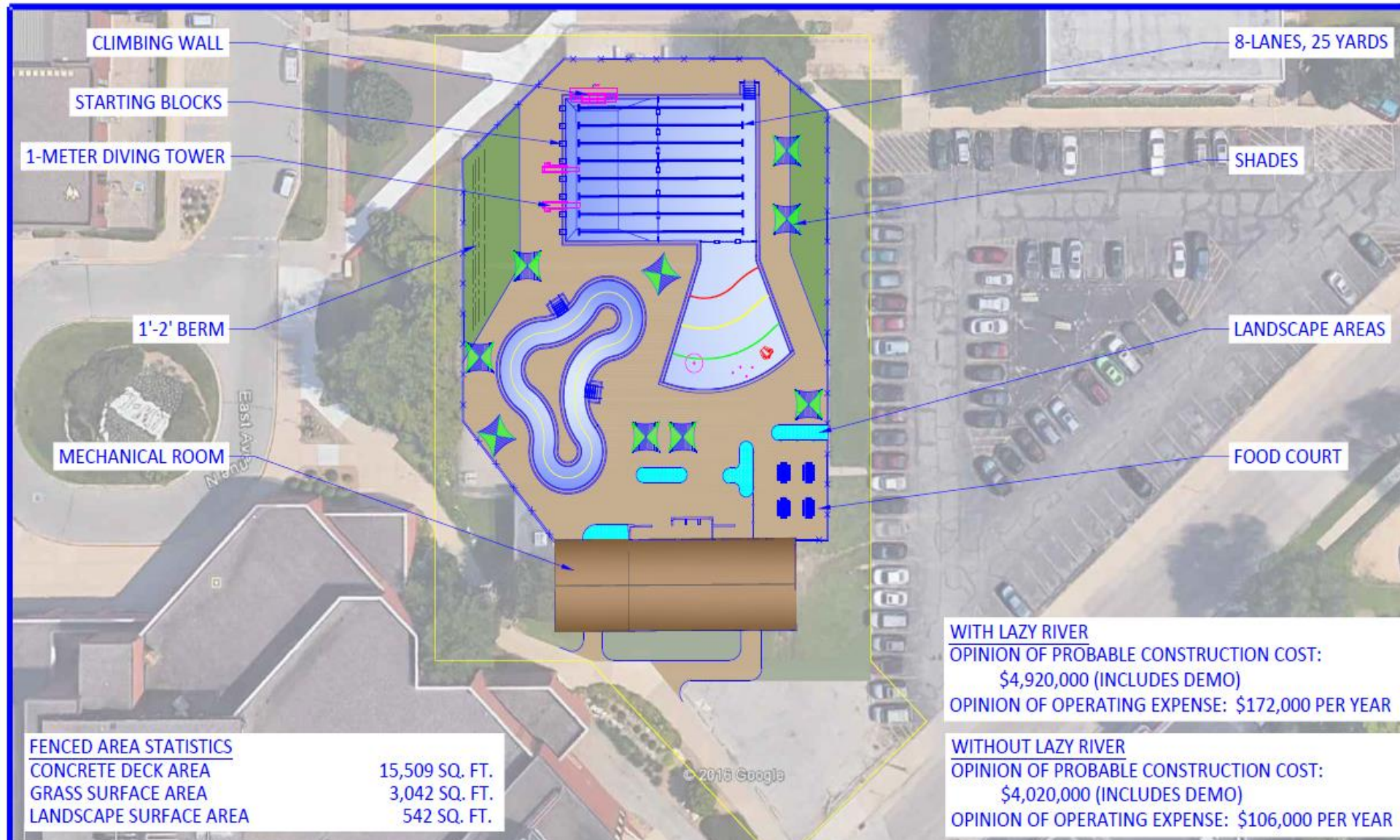

CLIMBING WALL
 STARTING BLOCKS
 1-METER DIVING TOWER
 1'-2' BERM
 MECHANICAL ROOM

8-LANES, 25 YARDS
 SHADES
 LANDSCAPE AREAS
 FOOD COURT

FENCED AREA STATISTICS	
CONCRETE DECK AREA	15,509 SQ. FT.
GRASS SURFACE AREA	3,042 SQ. FT.
LANDSCAPE SURFACE AREA	542 SQ. FT.

WITH LAZY RIVER
 OPINION OF PROBABLE CONSTRUCTION COST:
 \$4,920,000 (INCLUDES DEMO)
 OPINION OF OPERATING EXPENSE: \$172,000 PER YEAR

WITHOUT LAZY RIVER
 OPINION OF PROBABLE CONSTRUCTION COST:
 \$4,020,000 (INCLUDES DEMO)
 OPINION OF OPERATING EXPENSE: \$106,000 PER YEAR

VERSION #6 - CONCEPTUAL SITE PLAN STATISTICS	
BATHHOUSE AREA	3,743 SQ. FT.
MAIN POOL SURFACE AREA	6,743 SQ. FT.
LAZY RIVER SURFACE AREA	1,933 SQ. FT.
MAIN POOL PATRON CAPACITY	387 PATRONS
LAZY RIVER PATRON CAPACITY	129 PATRONS
TOTAL PATRON CAPACITY	516 PATRONS

VERSION #6 - WATER DEPTH BREAKDOWN		
0 - 2'	1,206 SQ. FT.	14%
2' - 4'	2,641 SQ. FT.	31%
LAZY RIVER AREA	1,933 SQ. FT.	22%
4' +	2,896 SQ. FT.	33%

BURBACH AQUATICS, INC.
 ARCHITECTS & ENGINEERS

Your Quality choice for Aquatic Design!
 WWW.BURBACHAQUATICS.COM
 BAAE@CENTURYTEL.NET

NORTH

PROJECT NO. _____
 SHEET NO. _____
 DATE _____
 DESIGNER _____
 CHECKED BY _____
 APPROVED BY _____

BURBACH AQUATICS, INC.
 ARCHITECTS & ENGINEERS
 400 LA CROSSE STREET
 LA CROSSE, WI 54601
 (608) 785-1111
 WWW.BURBACHAQUATICS.COM

CITY HALL 1ST FLOOR
 400 LA CROSSE STREET
 LA CROSSE, WI 54601

CONCEPTUAL SITE PLAN VERSION #6
 LACROSSE FAMILY AQUATIC CENTER

4-19-2017

PH1-S2

BURBACH AQUATICS, INC.
 ARCHITECTS & ENGINEERS

Your Quality Choice for Aquatic Design!

www.burbachaquatics.com | baae@centurytel.net

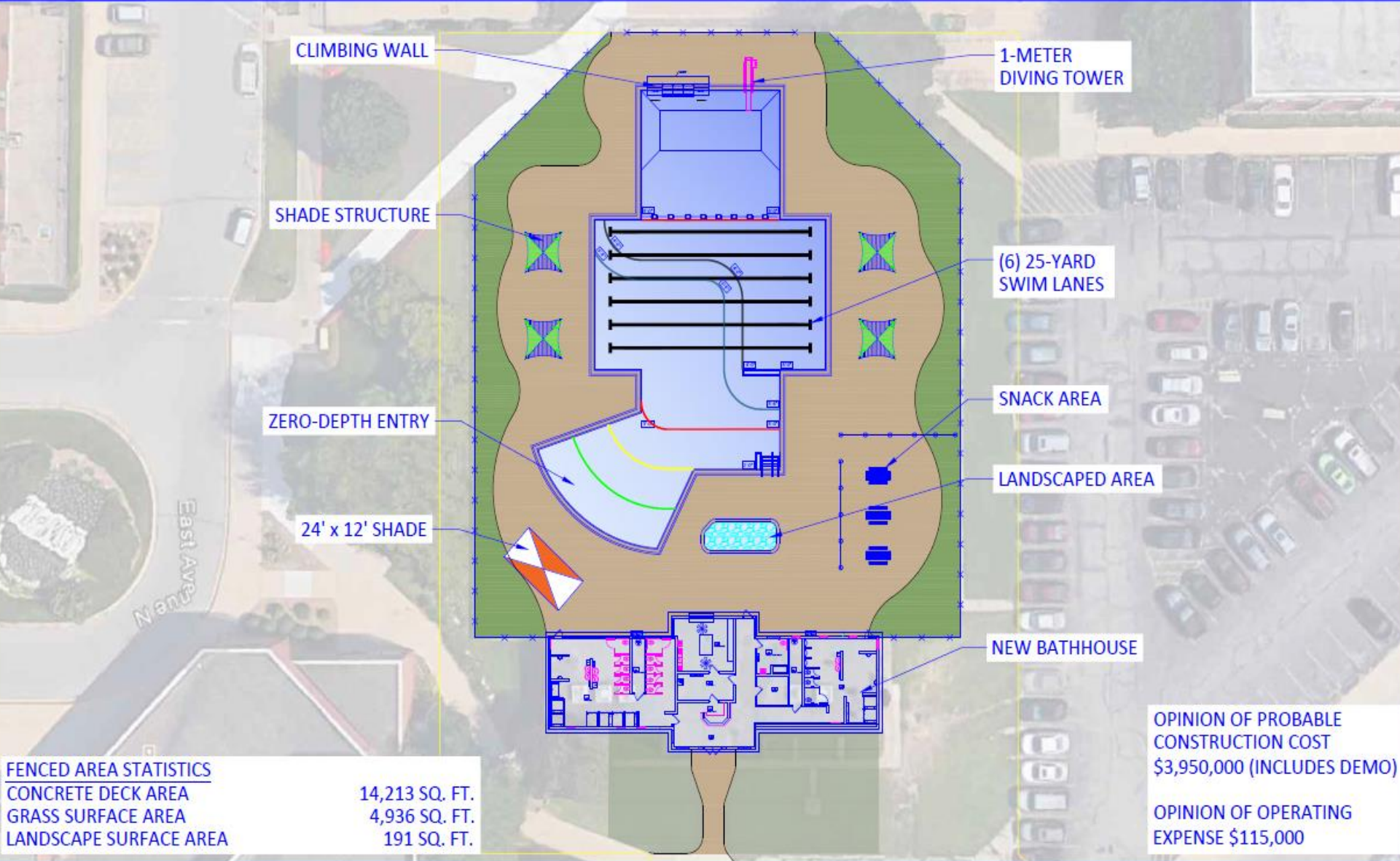

FENCED AREA STATISTICS

CONCRETE DECK AREA	14,213 SQ. FT.
GRASS SURFACE AREA	4,936 SQ. FT.
LANDSCAPE SURFACE AREA	191 SQ. FT.

OPINION OF PROBABLE CONSTRUCTION COST
\$3,950,000 (INCLUDES DEMO)

OPINION OF OPERATING EXPENSE \$115,000

VERSION #7 - CONCEPTUAL SITE PLAN STATISTICS

BATHHOUSE AREA	3,351 SQ. FT.
MAIN POOL SURFACE AREA	7,596 SQ. FT.
POOL PATRON CAPACITY	458 PATRONS

VERSION #7 - WATER DEPTH BREAKDOWN

0 - 2'	1,019 SQ. FT.	14%
2' - 4'	3,065 SQ. FT.	40%
4' +	3,512 SQ. FT.	46%

BURBACH AQUATICS, INC.
ARCHITECTS & ENGINEERS

"Your Quality choice for Aquatic Design!"
WWW.BURBACHAQUATICS.COM
BAAE@CENTURYTEL.NET



PROJECT NO.	PH1-S2
DATE	4-19-2017
CLIENT	LACROSSE FAMILY AQUATIC CENTER
PROJECT ADDRESS	CITY HALL 1ST FLOOR 400 LA CROSSE STREET LA CROSSE, WI 54601
ARCHITECT/ENGINEER	BURBACH AQUATICS, INC. 520 LAKEVIEW AVENUE LA CROSSE, WI 54601 TEL: 715.785.9411 WWW.BURBACHAQUATICS.COM
SCALE	AS SHOWN

BURBACH AQUATICS, INC.
ARCHITECTS & ENGINEERS

Your Quality Choice for Aquatic Design!

CLIMBING WALL

1-METER DIVING TOWER

(8) 25-YARD SWIM LANES

SHADE STRUCTURE

STARTING BLOCKS

ZERO-DEPTH ENTRY

SNACK AREA

24' x 12' SHADE

NEW BATHHOUSE

PROJECT NO.	172.11
DATE	4-19-2017
SCALE	PHI-S2
PROJECT NAME	CONCEPTUAL SITE PLAN VERSION #7
CLIENT	LACROSSE FAMILY AQUATIC CENTER
PROJECT ADDRESS	CITY HALL 1ST FLOOR 400 LA CROSSE STREET LA CROSSE, WI 54601
PROJECT CONTACT	BURBACH AQUATICS, INC. 10045 WISCONSIN 1500 RD - FLS WA 531 2120 WISCONSIN 1500 RD - FLS WA 531 1110 WISCONSIN 1500 RD - FLS WA 531 1110 WISCONSIN 1500 RD - FLS WA 531
PROJECT CONTACT	WWW.BURBACHAQUATICS.COM

FENCED AREA STATISTICS	
CONCRETE DECK AREA	14,883 SQ. FT.
GRASS SURFACE AREA	4,272 SQ. FT.

OPINION OF PROBABLE
CONSTRUCTION COST
\$4,025,000 (INCLUDES DEMO)

OPINION OF OPERATING
EXPENSE \$115,000

VERSION #7 - CONCEPTUAL SITE PLAN STATISTICS	
BATHHOUSE AREA	3,351 SQ. FT.
MAIN POOL SURFACE AREA	7,684 SQ. FT.
POOL PATRON CAPACITY	466

VERSION #7 - WATER DEPTH BREAKDOWN		
0 - 2'	1,021 SQ. FT.	13%
2' - 4'	2,853 SQ. FT.	37%
4' +	3,810 SQ. FT.	50%

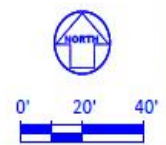

VORTEX POOL

1-METER DIVING TOWER

CLIMBING WALL



Losey Blvd

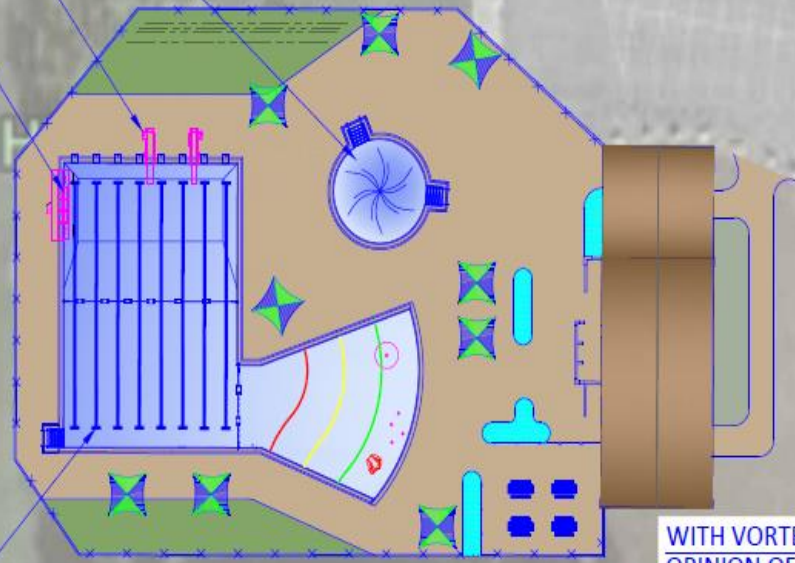

(8) 25-YARD SWIM LANES

FENCED AREA STATISTICS	
CONCRETE DECK AREA	16,685 SQ. FT.
GRASS SURFACE AREA	3,042 SQ. FT.
LANDSCAPE SURFACE AREA	542 SQ. FT.

WITH VORTEX POOL
 OPINION OF PROBABLE CONSTRUCTION COST:
 \$4,070,000
 OPINION OF OPERATING EXPENSE: \$136,000 PER YEAR

WITHOUT VORTEX POOL
 OPINION OF PROBABLE CONSTRUCTION COST:
 \$3,820,000
 OPINION OF OPERATING EXPENSE: \$106,000 PER YEAR

VERSION #8 CONCEPTUAL SITE PLAN STATISTICS

BATHHOUSE AREA	3,743 SQ. FT.
MAIN POOL SURFACE AREA	6,743 SQ. FT.
VORTEX SURFACE AREA	758 SQ. FT.
POOL PATRON CAPACITY	391 PATRONS
VORTEX PATRON CAPACITY	50 PATRONS
TOTAL PATRON CAPACITY	441 PATRONS

VERSION #8 - WATER DEPTH BREAKDOWN

0 - 2'	1,205 SQ. FT.	16%
2' - 4'	2,643 SQ. FT.	35%
VORTEX POOL AREA	758 SQ. FT.	10%
4' +	2,895 SQ. FT.	39%

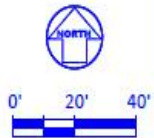

PROJECT NO.	PHI-S2
DATE	4-19-2017
PROJECT NAME	CONCEPTUAL SITE PLAN VERSION #8
CLIENT	LACROSSE FAMILY AQUATIC CENTER
DESIGNER	CITY OF LACROSSE 1000 W. WASHINGTON ST. LACROSSE, WI 54601
OWNER	LACROSSE FAMILY AQUATIC CENTER
ARCHITECT	BURBACH AQUATICS, INC. 1000 W. WASHINGTON ST. LACROSSE, WI 54601 WWW.BURBACHAQUATICS.COM BAAE@CENTURYTEL.NET

BURBACH AQUATICS, INC.
ARCHITECTS & ENGINEERS
Your Quality Choice for Aquatic Design!
 www.burbachaquatics.com | baee@centurytel.net

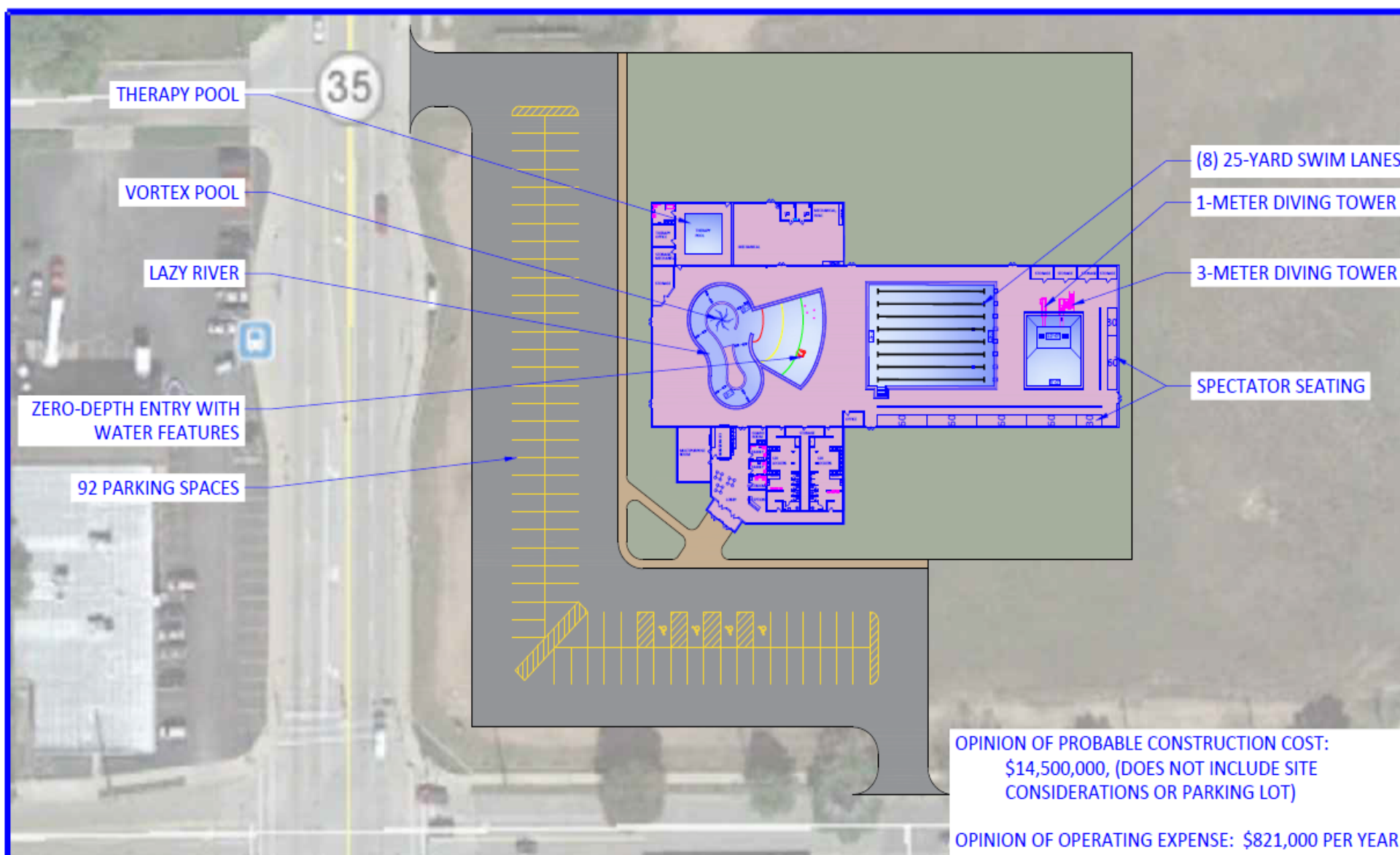

OPINION OF PROBABLE CONSTRUCTION COST:
 \$14,500,000, (DOES NOT INCLUDE SITE
 CONSIDERATIONS OR PARKING LOT)

OPINION OF OPERATING EXPENSE: \$821,000 PER YEAR

VERSION #9 CONCEPTUAL SITE PLAN STATISTICS

BATHHOUSE AREA	6,930 SQ. FT.
NATATORIUM AREA	25,375 SQ. FT.
MULTIPURPOSE ADDITION AREA	600 SQ. FT.
THERAPY ADDITION AREA	1,691 SQ. FT.
TOTAL BUILDING AREA	34,596 SQ. FT.

VERSION #9 CONCEPTUAL SITE PLAN STATISTICS

LAZY RIVER LENGTH	150 LN. FT.
COMPETITION POOL SURFACE AREA	4,202 SQ. FT.
RECREATION POOL SURFACE AREA	3,544 SQ. FT.
THERAPY POOL SURFACE AREA	530 SQ. FT.
DIVING POOL SURFACE AREA	1,268 SQ. FT.
TOTAL WATER SURFACE AREA	9,544 SQ. FT.

BURBACH AQUATICS, INC.
 ARCHITECTS & ENGINEERS

"Your Quality choice for Aquatic Design!"

WWW.BURBACHAQUATICS.COM
 BAAE@CENTURYTEL.NET



BURBACH AQUATICS, INC. 400 LA CROSSE STREET LA CROSSE, WI 54601 WWW.BURBACHAQUATICS.COM	CITY HALL 1ST FLOOR 400 LA CROSSE STREET LA CROSSE, WI 54601	PROJECT NO.: 2017 0401
		SHEET NO.: PH1-S2
CONCEPTUAL SITE PLAN VERSION #9 LACROSSE FAMILY AQUATIC CENTER		DATE: 4-19-2017

BURBACH AQUATICS, INC.
 ARCHITECTS & ENGINEERS

Your Quality Choice for Aquatic Design!

www.burbachaquatics.com | baae@centurytel.net

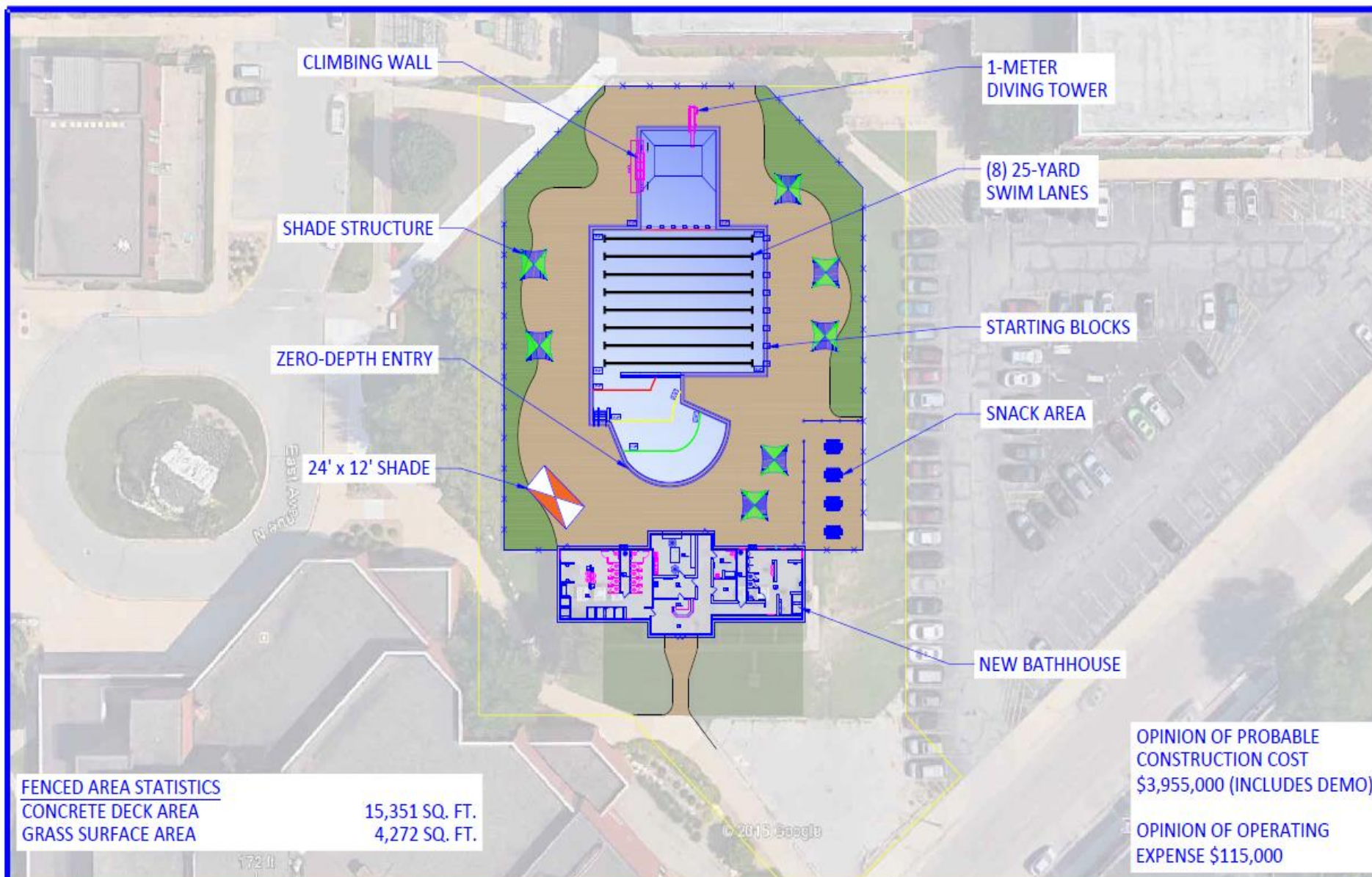

FENCED AREA STATISTICS
 CONCRETE DECK AREA 15,351 SQ. FT.
 GRASS SURFACE AREA 4,272 SQ. FT.

OPINION OF PROBABLE
 CONSTRUCTION COST
 \$3,955,000 (INCLUDES DEMO)
 OPINION OF OPERATING
 EXPENSE \$115,000

DATE	
NO.	
DESCRIPTION	
BY	
DATE	
PROJECT NO.	
PROJECT NAME	
CLIENT NAME	
CLIENT ADDRESS	
CLIENT PHONE	
CLIENT FAX	
CLIENT EMAIL	
PROJECT LOCATION	
CITY	
STATE	
COUNTY	
ZIP	
CONCEPTUAL SITE PLAN VERSION #10	
LACROSSE FAMILY AQUATIC CENTER	
DATE	4-21-2017
PROJECT	
PHI-52	

VERSION #10 - CONCEPTUAL SITE PLAN STATISTICS	
BATHHOUSE AREA	3,351 SQ. FT.
MAIN POOL SURFACE AREA	7,216 SQ. FT.
POOL PATRON CAPACITY	447

VERSION #10 - WATER DEPTH BREAKDOWN		
0 - 2'	1,021 SQ. FT.	14%
2' - 4'	2,853 SQ. FT.	40%
4' +	3,342 SQ. FT.	46%

BURBACH AQUATICS, INC.
 ARCHITECTS & ENGINEERS
Your Quality choice for Aquatic Design!
 WWW.BURBACHAQUATICS.COM
 BAAE@CENTURYTEL.NET

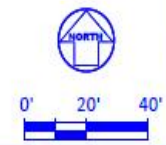

BURBACH AQUATICS, INC.
 ARCHITECTS & ENGINEERS
Your Quality Choice for Aquatic Design!
 www.burbachaquatics.com | baae@centurytel.net

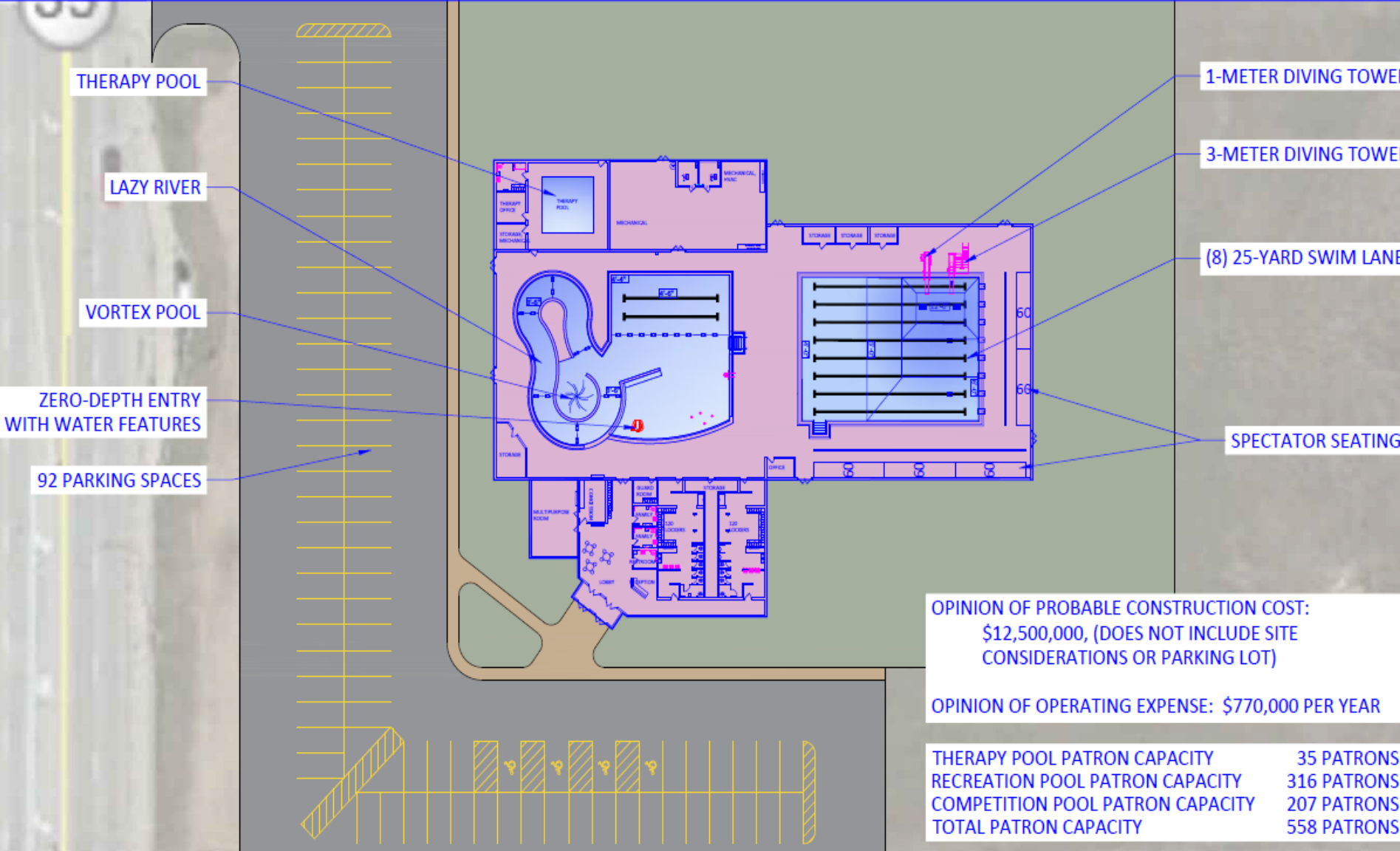

OPINION OF PROBABLE CONSTRUCTION COST:
\$12,500,000, (DOES NOT INCLUDE SITE
CONSIDERATIONS OR PARKING LOT)

OPINION OF OPERATING EXPENSE: \$770,000 PER YEAR

THERAPY POOL PATRON CAPACITY	35 PATRONS
RECREATION POOL PATRON CAPACITY	316 PATRONS
COMPETITION POOL PATRON CAPACITY	207 PATRONS
TOTAL PATRON CAPACITY	558 PATRONS

PROJECT NO.	PH1-S2
DATE	4-21-2017
PROJECT NAME	CONCEPTUAL SITE PLAN VERSION #11 LA CROSSE FAMILY AQUATIC CENTER
CLIENT	CITY OF LA CROSSE, WI
DESIGNER	BURBACH AQUATICS, INC.
PROJECT ADDRESS	CITY HALL 1ST FLOOR 400 LA CROSSE STREET LA CROSSE, WI 54601
PROJECT CONTACT	LA CROSSE AQUATIC CENTER
PROJECT PHONE	734.242.4663
PROJECT FAX	734.242.4663
PROJECT WEBSITE	WWW.BURBACHAQUATICS.COM
PROJECT EMAIL	BAAE@CENTURYTEL.NET

BATHHOUSE AREA	6,930 SQ. FT.
NATATORIUM AREA	21,770 SQ. FT.
MULTIPURPOSE ADDITION AREA	600 SQ. FT.
THERAPY ADDITION AREA	1,691 SQ. FT.
TOTAL BUILDING AREA	30,991 SQ. FT.

LAZY RIVER LENGTH	150 LN. FT.
COMPETITION POOL SURFACE AREA	4,230 SQ. FT.
RECREATION POOL SURFACE AREA	4,754 SQ. FT.
THERAPY POOL SURFACE AREA	530 SQ. FT.
TOTAL WATER SURFACE AREA	9,514 SQ. FT.

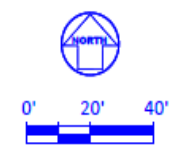

BURBACH AQUATICS, INC.
ARCHITECTS & ENGINEERS

Your Quality Choice for Aquatic Design!

www.Burbachaquatics.com | baae@centurytel.net

Opinion of Operating Costs- Conceptual Site Plans	
Version #1- (With Lazy River)- Existing Memorial Site	\$172,000
Version #1- (Without Lazy River)- Existing Memorial Site	\$106,000
Version #2- Existing Memorial Site	\$99,000
Version #3- (With Lazy River)- Forest Hills Lower Site	\$172,000
Version #3- (Without Lazy River)- Forest Hills Lower Site	\$106,000
Version #4- Indoor Pool Option- St. Andrews (Trane Site)	\$763,000
Version #5- Erickson Pool Expansion	\$12,000
Version #6- (With Lazy River)- Existing Memorial Site	\$172,000
Version #6- (Without Lazy River)- Existing Memorial Site	\$106,000
Version #7- Existing Memorial Site	\$115,000
Version #7- Existing Memorial Site	\$115,000
Version #8- (With Vortex Pool)- Forest Hills Lower Site	\$136,000
Version #8- (Without Vortex Pool)- Forest Hills Lower Site	\$106,000
Version #9- Indoor Pool Option- St. Andrews (Trane Site)	\$821,000
Version #10- Existing Memorial Site	\$115,000
Version #11- Indoor Pool Option- St. Andrews (Trane Site)	\$770,000

Public Input Sessions

1. How many people in each age group live at your residence?

<u>Question 1</u>		
0-19	352	
20-29	61	
30-39	90	
40-49	191	
50-59	98	
60+over	114	



2. Should the City of La Crosse build a new replacement outdoor swimming pool facility?

<u>Question 2</u>		
Yes	178	
No	88	
Did not answer	18	

3. Should the City of La Crosse build a new indoor swimming pool facility?

<u>Question 3</u>		
Yes	124	
No	146	
Did not answer	14	



4. How often would you anticipate using an outdoor aquatic facility?

Question 4

1.97 # of times weekly

5. How often would you anticipate using an indoor aquatic facility?

Question 5

1.62 # of times weekly

6. Would you or your family use a new indoor/outdoor swimming pool for any of the following?

<u>Question 6</u>		
Recreation	256	
Health Reasons	189	
Competition	81	
Swim Lessons	130	
No Opinion	11	

7. In a new indoor/outdoor pool facility, which of the following would you favor?

Question 7		
Open Swimming Area	238	
Lap Swimming Area	206	
Lounge Chairs	177	
Zero Depth Entry	157	
Diving	155	
Shaded picnic area	150	
Concession area	141	
Waterslide	132	
Lazy River	104	
Climbing Wall	90	
Drop slide	80	
Dry Playground area	78	
Wet Playground area	77	
Vortex Pool	61	
Sand volleyball area	53	
Sand Playground area	49	

8. Out of the 5 Conceptual Site plans presented, which one do you prefer most?

<u>Question 8</u>					
Ranking 1=Most preferred 5=least preferred	Version #5	Version #6	Version #10	Version #8	Version #11
1	7	58	104	23	83
2	8	60	39	28	4
3	24	20	20	40	11
4	30	16	13	25	26
5	61	6	12	26	50



Outdoor Pool Considerations

- Construction Cost of \$1.4M-\$4.9M depending on site and design
- Operational cost \$12,000 to \$172,000 per year
- Open on average 55 days a year, weather dependent
- Programming gaps in existing pools identified as lap swimming, competition and therapy programs
- Revenues:
 - Potential increase for competition events
 - Existing programming will not likely see increases in revenues
 - Attendance revenue increase of \$8,000 anticipated
- Hidden revenue from hotel taxes etc. during competition events



Indoor Pool Considerations

- Construction cost \$12M - \$14.5 million or more depending on features and construction type.
- Operational Costs \$763,000-\$821,000
- Revenues:
 - Potential increase for competition events
 - Potential revenue estimated \$200,000-\$300,000
- Operates year round, with scheduled shutdown for cleaning and maintenance.
- Programming gaps in existing pools identified as lap swimming, competition and therapy programs
- Indoor programming could enhance existing outdoor programming.
- Building could incorporate retractable roof to allow summer feel and be used for overflow at peak capacity times.
- Hidden revenue from hotel taxes etc. during competition events



Outdoor Pool Conclusions

- Adding an outdoor pool will increase attendance based on historical attendance records.
- Operational costs for an additional community facility will not be offset by anticipated revenues.
- The City should consider outdoor options between 6,700 and 8,700 square feet.
- Natant demand and review of existing facilities show a shortage of open swim areas and lap swimming areas.
- Existing facilities are currently not capable of hosting recreational/competitive swim meets.
- City currently does not provide a summer recreation program for competitive swimming.



Indoor Pool Conclusion

- Existing Indoor Pools lack recreational waters.
- Existing Indoor Pools show a gap in availability for lap swimming during (peak time) from 3-7 pm and weekends
- Programming should consider lessons, competition events, aquatic exercise and special events.
- Indoor Pool between 5,000 and 7,000 square feet minimum with recreational water.
- City should consider collaborative effort with stakeholders in the La Crosse Service Area.

Feasibility Study Conclusion

- Based on the meetings conducted with the pool committee and the public input sessions there is nearly a 50/50 divide in the community for citizens that want a third outdoor pool facility and citizens that want an indoor facility. However, it was a nearly unanimous opinion from citizens that the community of La Crosse needs additional swimming area for lap swimming, competition and to mitigate the overcrowding in the existing facilities, this opinion is supported in BAI's natant demand analysis and feasibility study.