



TASK NAME: WILC-FR03

TASK DESCRIPTION: FIBER OPTIC CONDUIT PLACEMENT

SITE LOCATION: LACROSSE, WI, USA



3701 COMMUNICATIONS WAY
EVANSVILLE, IN, 47715



1100 E. WOODFIELD ROAD, SUITE 500
SCHAUMBURG, ILLINOIS 60173
TEL: 847-908-8400
COA# 3620-11
www.fullerton-us.com

PROJECT INFORMATION

TASK NAME: WILC-FR03
 TASK DESCRIPTION: FIBER OPTIC CONDUIT PLACEMENT
 SITE LOCATION: LACROSSE, WI, USA
 SITE TYPE: UNDERGROUND FIBER-OPTIC CONSTRUCTION
 JURISDICTION: LACROSSE, WI, USA
 APN: -
 ZONING CLASSIFICATION: -
 OCCUPANCY TYPE: -
 CONSTRUCTION TYPE: -
 APPLICANT: METRO FIBERNET, LLC
 ADDRESS: 3701 COMMUNICATIONS WAY
EVANSVILLE, IN, 47715
 CONTACT: TARAN WELCHLIN
 PHONE: (608) 606-2043
 EMAIL: TARAN.WELCHLIN@METRONET.COM

NOTE: DRAWING SCALES ARE FOR 11"x17" SHEETS UNLESS OTHERWISE NOTED

PROJECT CONSULTANTS

PROJECT MANAGER: FULLERTON ENGINEERING CONSULTANTS, LLC
 ADDRESS: 1100 E. WOODFIELD ROAD, SUITE 500
 CONTACT: MICHELLE KAMINSKI
 PHONE: (616) 262-8400
 EMAIL: MKAMINSKI@FULLERTON-US.COM
 ENGINEER: FULLERTON ENGINEERING CONSULTANTS, LLC
 ADDRESS: 1100 E. WOODFIELD ROAD, SUITE 500
SCHAUMBURG, ILLINOIS 60173
 EOR: DAN SMITH, P.E.
 PHONE: 847-908-8521
 EMAIL: DSMITH@FULLERTONENGINEERING.COM
 POWER COMPANY:
 PHONE:
 TELEPHONE COMPANY:
 PHONE:

SCOPE OF WORK

THE SCOPE OF WORK CONSISTS OF:
 INSTALLATION OF:
 • 1,626' OF DIRECTIONAL BORE PATH
 • 5,605' OF 1.25" CONDUIT
 • (3) L-HANDHOLE 30X48X24
 ALL MATERIAL SHALL BE INSTALLED BY THE CONTRACTOR, UNLESS STATED OTHERWISE.

SITE LOCATION MAP

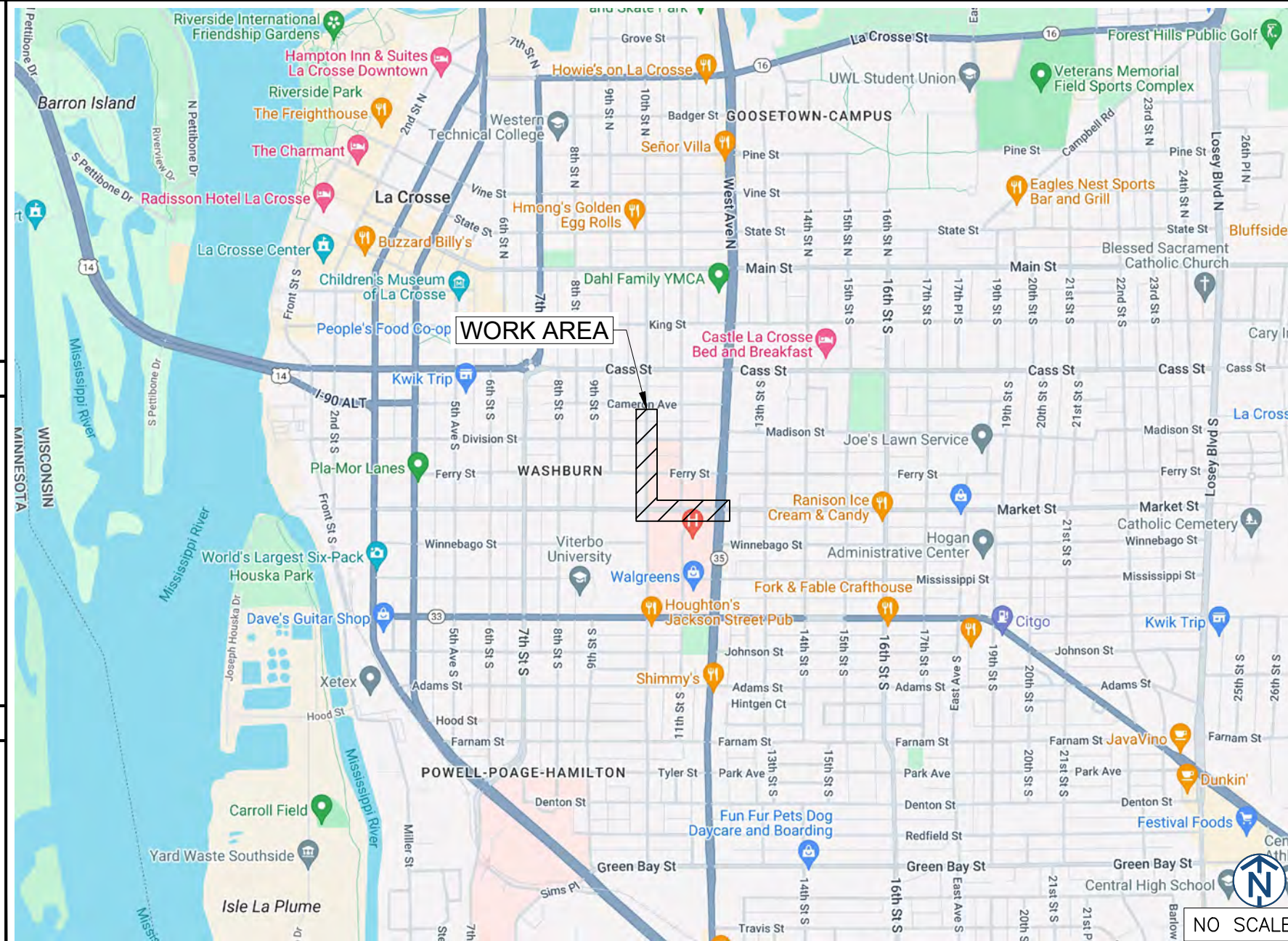

REV	DATE	DESCRIPTION	BY
A	07/22/24	ISSUED FOR REVIEW	HT
B	10/15/24	REVISED	BP
C	11/05/24	REVISED	BP

I HEREBY CERTIFY THAT THESE DRAWINGS WERE PREPARED BY ME OR UNDER MY DIRECT SUPERVISION AND CONTROL, AND TO THE BEST OF MY KNOWLEDGE AND BELIEF COMPLY WITH THE REQUIREMENTS OF ALL APPLICABLE CODES.

TASK NAME
WILC-FR03

TASK DESCRIPTION
FIBER OPTIC CONDUIT PLACEMENT

PROJECT AREA
LACROSSE, WI, USA

SHEET SCALE
N.T.S.

SHEET TITLE
TITLE SHEET









GRID NUMBER

SHEET NUMBER
T-1







NO SCALE

LEGEND











PROPOSED

-  PROPOSED OPEN CUT TRENCH
-  PROPOSED DIRECTIONAL BORE
-  PROPOSED BORE PIT
-  PROPOSED L-HANDHOLE(30X48X24)
-  PROPOSED M-HANDHOLE(24X36X18)
-  PROPOSED B-UTILITY BOXES(17X30X18)
-  PROPOSED TERMINAL BOXES(13X24X15)
-  PROPOSED DROP BOXES(11X11X12)





SEWER

-  EXISTING SEWER MAIN
-  EXISTING SEWER MAIN (ABANDON)
-  EXISTING STORM SEWER MAIN
-  EXISTING STORM MANHOLE
-  EXISTING SEWER MANHOLE
-  EXISTING SEWER CATCH BASIN
-  EXISTING SEWER INLET



WATER

-  EXISTING WATER MAIN
-  EXISTING WATER MAIN (ABANDON)
-  EXISTING WATER SHUT OFF
-  EXISTING FIRE CISTERN MANHOLE
-  EXISTING WATER CAP
-  EXISTING WATER MANHOLE
-  EXISTING WATER VALVE
-  EXISTING WATER METER
-  EXISTING FIRE HYDRANT
-  EXISTING WATER REDUCER











GAS

-  EXISTING GAS MAIN
-  EXISTING GAS MAIN (DEAD)
-  EXISTING GAS CAP
-  EXISTING GAS REDUCER
-  EXISTING GAS MANHOLE
-  EXISTING GAS VALVE
-  EXISTING GAS METER

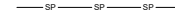
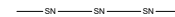
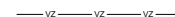























DEO/ELECTRIC

-  EXISTING DEO/ELECTRIC
-  EXISTING STREET LIGHT CONTROL BOX
-  EXISTING TRAFFIC LIGHT CONTROL BOX
-  EXISTING STREET LIGHT HANDHOLE
-  EXISTING TRAFFIC LIGHT HANDHOLE
-  EXISTING RED LIGHT CAMERA POLE
-  EXISTING STREET LIGHT POLE
-  EXISTING TRAFFIC LIGHT POLE
-  EXISTING DEO POLE
-  EXISTING ELECTRIC MANHOLE
-  EXISTING ELECTRIC HANDHOLE
-  EXISTING RED LIGHT FLASH POLE

COMMUNICATIONS

-  EXISTING AT&T
-  EXISTING AT&T (ABANDON)
-  EXISTING COMMUNICATIONS
-  EXISTING MCI
-  EXISTING SPRINT
-  EXISTING SUNESYS
-  EXISTING VERIZON
-  EXISTING CITY FIBER
-  EXISTING AT&T MANHOLE
-  EXISTING COMMUNICATIONS MANHOLE
-  EXISTING MCI
-  EXISTING SPRINT/NEXTEL MANHOLE
-  EXISTING SUNESYS MANHOLE
-  EXISTING VERIZON MANHOLE

MISCELLANEOUS

-  EXISTING FENCE
-  EXISTING CONSTRUCTION FENCE
-  EXISTING GUARDRAIL
-  EXISTING PROPERTY LINE/ R.O.W.
-  EXISTING BIKE RACK
-  EXISTING TREE
-  EXISTING BUSH
-  EXISTING STREET SIGN POST
-  EXISTING POST/BOLLARD
-  EXISTING GROUND LIGHT
-  EXISTING UTILITY POLE
-  EXISTING STANDPIPE
-  EXISTING ADA RAMP
-  EXISTING MISCELLANEOUS MANHOLE
-  EXISTING GARBAGE CAN
-  EXISTING PARK DISTRICT MANHOLE
-  EXISTING MONITORING WELL
-  EXISTING FIRE ALARM
-  EXISTING STREET PARKING PAY BOX
-  EXISTING PEDESTAL
-  EXISTING MAILBOX
-  EXISTING NEWSPAPER BOX
-  EXISTING PHONE
-  EXISTING SPRINKLER CONTROL BOX
-  EXISTING SPRINKLER VALVE
-  EXISTING SUPPORT COLUMN

REV	DATE	DESCRIPTION	BY
A	07/22/24	ISSUED FOR REVIEW	HT
B	10/15/24	REVISED	BP
C	11/05/24	REVISED	BP

I HEREBY CERTIFY THAT THESE DRAWINGS WERE PREPARED BY ME OR UNDER MY DIRECT SUPERVISION AND CONTROL, AND TO THE BEST OF MY KNOWLEDGE AND BELIEF COMPLY WITH THE REQUIREMENTS OF ALL APPLICABLE CODES.

TASK NAME
WILC-FR03

TASK DESCRIPTION
FIBER OPTIC CONDUIT PLACEMENT

PROJECT AREA
LACROSSE, WI, USA

SHEET SCALE
N.T.S.

SHEET TITLE
LEGEND

GRID NUMBER

SHEET NUMBER
T-3

1. THE ENCLOSED DESIGN MAY IMPLY EXISTING UTILITIES. THE UTILITIES HAVE NOT BEEN FIELD VERIFIED FOR LOCATION. THEREFORE, ALL UTILITIES IMPLIED WITHIN THIS DOCUMENT ARE TO BE REFERRED TO AS A "REFERENCE TOOL". IT IS THE RESPONSIBILITY OF THE GENERAL CONTRACTOR AND/OR ITS SUBCONTRACTOR TO VERIFY THESE UTILITIES USING ANY AND ALL METHODS AND INSTRUMENTS AVAILABLE IF/WHEN NECESSARY. FULLERTON CANNOT IN GOOD FAITH GUARANTEE UTILITY LOCATIONS. ANY AND ALL DOCUMENTATION ON EXISTING UTILITIES HAS BEEN IMPLIED UTILIZING INFORMATION RETRIEVAL PROCESSES FROM EACH JURISDICTION INVOLVED (STATE, COUNTY AND/OR MUNICIPALITY, TO INCLUDE OTHERS).
2. IT IS THE RESPONSIBILITY OF THE GENERAL CONTRACTOR TO ENSURE ALL CONDUITS ARE PLACED WITHIN THE GIVEN & DEDICATED SPACE LICENSED FOR THIS PARTICULAR CLIENT. FULLERTON ENGINEERING CONSULTANTS, INC. (FULLERTON) WAS NOT RETAINED FOR THE PURPOSE OF SUPPORTING A SURVEY OF THE AREA AND PROPERTY BOUNDARIES, THEREFORE FULLERTON CAN NOT AND WILL NOT SUPPORT THE ACCURACY OF ANY IMPLIED BOUNDARY (I.E. PUBLIC WAY, PRIVATE PROPERTY, EASEMENT ETC.) NOR IS IT TO BE ASSUMED THAT THE SALE OF PROPERTIES HAS NOT OCCURRED DURING & AFTER FULLERTON'S RESPONSIBILITIES FOR THIS PROJECT HAVE PAST. ALL BOUNDARIES, EASEMENTS, PROPERTY LINES, ETC. ARE TO BE USED AS A GUIDELINE OR REFERENCE AND SHOULD NOT BE TAKEN LITERALLY. IT IS THE CONTRACTOR'S RESPONSIBILITY TO HAVE ASSOCIATED BOUNDARIES SURVEY STAKED IF SO QUESTIONED. ALL ASPECTS OF BOUNDARIES IMPLIED HEREIN, HAVE BEEN DERIVED THROUGH AVAILABLE MEDIA SUCH AS BUT NOT LIMITED TO (SIDWELL, GOOGLE EARTH PRO. MUNICIPAL, STATE, COUNTY, GIS, AND OTHER RECORD TYPES). FULLERTON DOES NOT AGREE NOR DISAGREE WITH THE ABOVE-MENTIONED RECORDS AS THEY ARE USED JUST A REFERENCE TOOL.
3. ALL BURIED OBSTRUCTIONS KNOWN BY FULLERTON ARE SHOWN ON THE CONSTRUCTION DRAWINGS. ANY AND ALL OTHERS ENCOUNTERED DURING CONSTRUCTION ARE THE RESPONSIBILITY OF THE CONTRACTOR TO LOCATE AND PROTECT.
4. CONTRACTOR IS RESPONSIBLE FOR LOCATING ALL UTILITIES 48 HOURS PRIOR TO CONSTRUCTION ACTIVITY.
5. SHORING MAY BE REQUIRED AND SHALL COMPLY TO O.S.H.A. STANDARDS.
6. ALL BURIED CONDUIT/CABLE WILL BE PLACED AT 30-48" MINIMUM COVER UNLESS SPECIFIED OR OTHERWISE NOTED ON THE CONSTRUCTION DRAWINGS.
7. ANY AND ALL IMPROVEMENTS, IF DAMAGED, SHALL BE RESTORED TO ORIGINAL OR BETTER CONDITION. THIS INCLUDES BUT IS NOT LIMITED TO: ASPHALT, CONCRETE PAVEMENT, CURBS, GUTTERS, SIDEWALKS, DRAINAGE DITCHES, EMBANKMENTS, SHRUBS, TREES, GRASS SOD, ETC..
8. ALL FIBER INSTALLATIONS SHALL OBSERVE A MINIMUM DYNAMIC BEND RADIUS OF 20X THE CABLE DIAMETER FOR ALL OSP FIBER SHEATHS AND 15X THE CABLE DIAMETER FOR ALL ISP FIBER SHEATHS. ADDITIONALLY, ALL INSTALLATIONS SHALL OBSERVE A MINIMUM STATIC BEND RADIUS OF 15X THE CABLE DIAMETER FOR ALL OSP FIBER SHEATHS AND 10X THE CABLE DIAMETER FOR ALL ISP FIBER SHEATHS. IF THE MANUFACTURER'S SPECIFICATIONS FOR BEND RADIUS ARE GREATER, THEN THEY SHALL BE FOLLOWED.
9. ALL NEW METALLIC AERIAL STRAND SHALL BE BONDED/GROUNDED (PREFERABLY TO THE POWER COMPANY NEUTRAL) PER LOCAL REQUIREMENTS. AT A MINIMUM, THE BONDING/GROUNDING PATTERN SHALL BE THE FIRST AND LAST POLE OF A RUN AND EVERY TENTH POLE IN THE RUN. SHOULD ONE OF THESE DESIGNATED POLES SUPPORT A POWER TRANSFORMER, THE POLES ON EITHER SIDE OF SAID POLE SHALL BE BONDED/GROUNDED AND THE PATTERN SHOULD CONTINUE EVERY TENTH POLE FROM THAT STARTING POINT.
10. ALL AERIAL FIBER OPTIC CABLES SHALL BE SECURELY LASHED TO AERIAL STRAND BY METHOD OF MECHANICAL LASHING CARRIAGE OR APPROVED EQUAL.
11. ALL FIBER OPTIC CABLES INSTALLED BELOW GRADE SHALL BE OF AN ARMORED VARIETY WITH METALLIC INNER SHEATH, OR BE PLACED WITH A METALLIC LOCATING WIRE TO FACILITATE FUTURE LOCATING SERVICES.
12. ALL CONDUIT OR DUCT CONSTRUCTION SHALL INCLUDE THE PLACEMENT OF PULLING TAPE OF SUFFICIENT SIZE AND GRADE TO FACILITATE THE INSTALLATION OF THE SPECIFIED FIBER TYPE THROUGH CONDUIT BEING UTILIZED (JETLINE USE TO BE APPROVED BY CLIENT).
13. ALL FUSION SPLICING SHALL BE COMPLETED BY A QUALIFIED FIBER SPLICER IN A CLEAN TEMPERATURE CONTROLLED TRUCK, TRAILER, OR SHELTER SPECIFICALLY TOOLED OR DESIGNED FOR THE PURPOSE OF FUSION SPLICING FIBER OPTIC CABLES IN A FIELD ENVIRONMENT.
14. ALL MECHANICAL SPLICES AND FACTORY ENDS SHALL BE KEPT CLEAN AND FREE FROM DUST, DIRT, OILS, AND SMEARS. CARE SHOULD BE TAKEN TO MATCH POLISH TYPES ON FACTORY ENDS.
15. CONTRACTOR SHALL BE RESPONSIBLE FOR ANY AND ALL CORRECTIONS TO WORK IDENTIFIED AS UNACCEPTABLE BY CLIENT, ENGINEER, OR INSPECTOR, DURING SITE INSPECTION ACTIVITIES AND/OR AS A RESULT OF TESTING. CONTRACTOR SHALL ALSO PROVIDE ALL AS-BUILT INFORMATION UPON COMPLETION OF INSPECTION.
16. CONTRACTOR SHALL KEEP THE SITE FREE FROM ACCUMULATING WASTE MATERIAL, DEBRIS, AND TRASH. AT THE COMPLETION OF THE WORK, CONTRACTOR SHALL REMOVE FROM THE SITE ALL REMAINING RUBBISH, IMPLEMENTS, TEMPORARY FACILITIES, AND SURPLUS MATERIALS. CONTRACTOR TO RETURN SITE TO PREVIOUS OR BETTER CONDITION.
17. DRAWINGS ARE INTENDED TO SHOW DESIGN INTENT. CONTRACTOR SHALL PROVIDE MATERIALS AND LABOR AS REQUIRED TO PRODUCE A COMPLETE AND FUNCTIONING SYSTEM WHILE MEETING ALL CODES AND SPECIFICATIONS. MODIFICATIONS MAY BE REQUIRED TO SUIT JOB DIMENSIONS OR CONDITIONS. SUCH MODIFICATIONS SHALL BE INCLUDED IN THE WORK. SAID DESIGN IS INTENDED TO AVOID DISRUPTION OF ANY HANDICAP RAMPS OR STRUCTURES AS DESCRIBED PER THE AMERICANS WITH DISABILITIES ACT OF 1990.

18. CONTRACTOR SHALL WORK WITH CLIENT TO IDENTIFY ALL CONTRACTOR SUPPLIED MATERIALS TO CONSTRUCT NETWORK PER SPECIFICATIONS.
19. THE CONTRACTOR SHALL PROVIDE ALL MATERIAL, EQUIPMENT, LABOR, INSTALLATION, RESTORATION, UTILITY RELOCATION CHARGES, JOB SITE DELIVERY COSTS AND INCIDENTALS TO COMPLETE THE DESCRIBED OR ILLUSTRATED WORK UNDER THIS CONTRACT.
20. ANY CHANGE-ORDER REQUEST MUST BE PRESENTED IN WRITING TO THE OWNER'S REPRESENTATIVE AND APPROVED PRIOR TO PROCEEDING WITH THE REQUESTED CHANGE.
21. THE ENGINEER WILL NOT BE RESPONSIBLE NOR ASSUME ANY LIABILITY FOR NEGLIGENT ACTS OR ERRORS OF OMISSIONS OF ANY CONTRACTOR, ANY SUBCONTRACTOR, OR ANY OF THE PERSONS (EXCEPT ENGINEER'S OWN EMPLOYEES) AT THE PROJECT SITE OR OTHERWISE PERFORMING ANY OF THE WORK OF THE PROJECT. ANY CONTRACTOR OR SUBCONTRACTOR, AS WELL AS THE ENGINEER, WILL BE RESPONSIBLE FOR HIS OWN SAFETY PROGRAM. NEITHER THE PROFESSIONAL ACTIVITIES OF THE ENGINEER, NOR THE PRESENCE OF THE ENGINEER OR HIS OR HER EMPLOYEES AND SUB-CONSULTANTS AT THE CONSTRUCTION SITE, SHALL RELIEVE ANY CONTRACTOR OF HIS OR HER OBLIGATIONS, DUTIES AND RESPONSIBILITIES INCLUDING, BUT NOT LIMITED TO, CONSTRUCTION MEANS, METHODS, SEQUENCE, TECHNIQUES OR PROCEDURES NECESSARY FOR PERFORMING, SUPERINTENDING OR COORDINATING ALL PORTIONS OF THE WORK OF CONSTRUCTION IN ACCORDANCE WITH THE CONTRACT DOCUMENTS AND ANY HEALTH OR SAFETY PRECAUTIONS REQUIRED BY ANY REGULATORY AGENCIES. THE ENGINEER AND HIS OR HER PERSONNEL HAVE NO AUTHORITY TO EXERCISE ANY CONTROL OVER ANY CONSTRUCTION CONTRACTOR OR OTHER ENTITY OR THEIR EMPLOYEES IN CONNECTION WITH ANY HEALTH OR SAFETY PRECAUTIONS.
22. ALL MATERIALS INSTALLED WITHIN THE LIMITS OF THIS PROJECT SHALL BE IN CONFORMANCE WITH STANDARD RECOMMENDATIONS OF THE NATIONAL ELECTRIC MANUFACTURER'S ASSOCIATION (NEMA) AND THE AMERICAN NATIONAL STANDARDS INSTITUTE (ANSI).
23. THE CONTRACTOR SHALL OBTAIN ALL PERMITS AND COMPLY WITH THE REQUIREMENTS OF ALL AGENCIES HAVING JURISDICTION OVER THE WORK AND SHALL COORDINATE HIS WORK WITH THE WORK PERFORMED BY OTHERS FOR THE PURPOSE OF INSTALLATION. THIS INCLUDES, BUT IS NOT LIMITED TO, ALL WORK WITH ALL PUBLIC AND PRIVATE UTILITIES AS WELL AS CITY AND STATE AGENCIES.
24. CONTRACTOR SHALL RECORD THE LOCATION AND ELEVATION OF ALL UTILITIES ENCOUNTERED, AND INSTALLATION OF NEW WORK, AS THE WORK PROGRESSES AND SHALL PREPARE RECORD DRAWINGS (RED-LINES) BASED ON HIS RECORDS. AS A PART OF THE RECORD DRAWINGS, CONTRACTOR SHALL ALSO PROVIDE HORIZONTAL AND VERTICAL CONFIGURATION OF CONDUITS WHERE MULTIPLE CONDUITS ARE INSTALLED. THESE RECORDS ARE TO BE SUPPLIED TO FULLERTON ENGINEERING AT COMPLETION OF WORK.
25. MAINTAIN MORE THAN 2'-0" VERTICAL CLEARANCE AND MORE THAN 4'-0" HORIZONTAL CLEARANCE BETWEEN EXISTING SEWER OR SEWER STRUCTURES AND UTILITY. IF CITY SEWER FACILITIES ARE DAMAGED DURING CONSTRUCTION, IT MUST BE REPORTED TO CITY ENGINEERING SECTION AND MUST BE REPAIRED BY A LICENSED DRAIN LAYER UNDER THE SUPERVISION OF THE MASON INSPECTOR.
26. NO STORAGE OF EQUIPMENT OR MATERIALS IN THE ROADWAY IS PERMITTED UNLESS THE CONTRACTOR OBTAINS WRITTEN PERMISSION FROM THE CITY, STATE, AND/OR GOVERNING BODY.
27. CONTRACTOR RESPONSIBLE FOR OBTAINING AND PROVIDING REVIEW AND DESIGN OF ANY AND ALL SHORING SYSTEMS PRIOR TO CONSTRUCTION.
28. THE ENGINEER SHALL BE NOTIFIED FOR DISPOSITION OF SITUATIONS WHERE THE CONDUIT CANNOT MAINTAIN SEPARATIONS PER PLAN.
29. THE CONTRACTOR IS RESPONSIBLE FOR THE RESTORATION OF THE AREAS DISTURBED BY CONSTRUCTION ACTIVITIES. CONTRACTOR IS TO PAY ALL FEES AND OBTAIN ALL PERMITS FOR RESTORATION. CONTRACTOR IS TO RESTORE ALL DAMAGED STRUCTURES AND UTILITIES TO THE SATISFACTION OF THE FACILITY OWNER OR THE GOVERNING BODY, IN THE EVENT THAT DAMAGE OCCURS.
30. USE EXTREME CAUTION NEAR ALL GAS FACILITIES DURING CONSTRUCTION AND RELATED EXCAVATION ACTIVITIES, HAND EXCAVATION IS REQUIRED TO VERIFY THE HORIZONTAL AND VERTICAL LOCATION OF GAS MAIN(S) PRIOR TO CROSSING AND WORKING WITHIN 3 FEET OF ALL GAS FACILITIES. A MINIMUM OF 3 FEET HORIZONTAL EDGE TO EDGE CLEARANCE IS REQUIRED FOR GAS MAINS WITH DIAMETERS OF 16 INCHES OR SMALLER, AND 5 FEET EDGE TO EDGE CLEARANCE FOR GAS MAINS WITH DIAMETERS 18 INCHES AND LARGER IN DIAMETER. THE USE OF CONCRETE, FLOW FILL, OR THE LIKE IS PROHIBITED WITHIN 24 INCHES OF ALL GAS FACILITIES, NOR SHALL IT ENCASE ANY GAS FACILITY. SAND IS TO BE USED AS A BUFFER BETWEEN FLOWABLE FILL AND ALL GAS FACILITIES, ANY DAMAGE TO GAS FACILITIES SHALL BE THE RESPONSIBILITY OF THE INSTALLING UTILITY AND THEIR CONTRACTORS.



REV	DATE	DESCRIPTION	BY
A	07/22/24	ISSUED FOR REVIEW	HT
B	10/15/24	REVISED	BP
C	11/05/24	REVISED	BP

I HEREBY CERTIFY THAT THESE DRAWINGS WERE PREPARED BY ME OR UNDER MY DIRECT SUPERVISION AND CONTROL, AND TO THE BEST OF MY KNOWLEDGE AND BELIEF COMPLY WITH THE REQUIREMENTS OF ALL APPLICABLE CODES.

TASK NAME
WILC-FR03

TASK DESCRIPTION
FIBER OPTIC CONDUIT PLACEMENT

PROJECT AREA
LACROSSE, WI, USA

SHEET SCALE
N.T.S.

SHEET TITLE
GENERAL NOTES

GRID NUMBER

SHEET NUMBER
GN-1



metronet

3701 COMMUNICATIONS WAY
EVANSVILLE, IN, 47715

Fullerton
DESIGN DEVELOP CONSTRUCT

1100 E. WOODFIELD ROAD, SUITE 500
SCHAUMBURG, ILLINOIS 60173
TEL: 847-908-8400
COA# 3620-11
www.fullerton-us.com

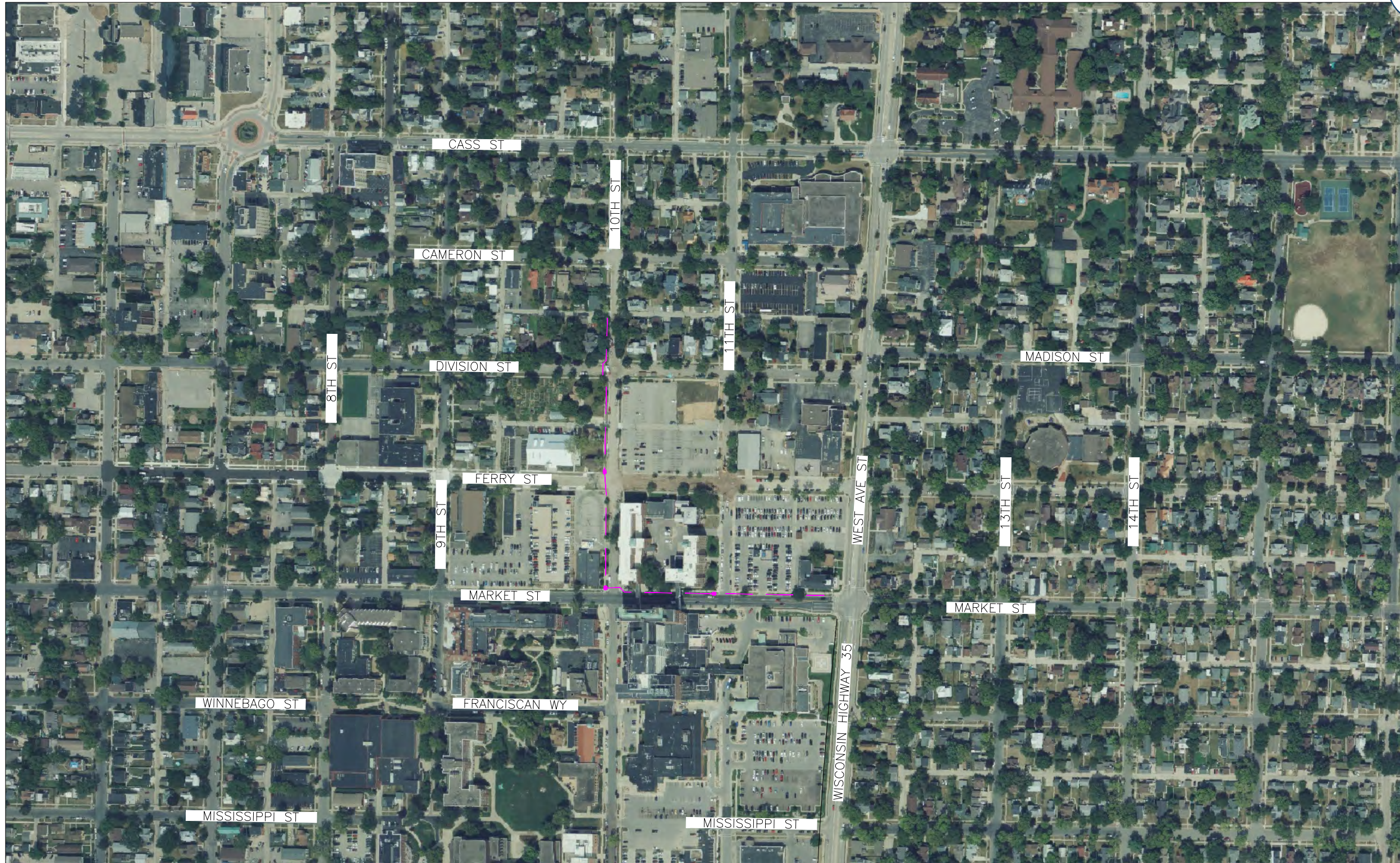

REV	DATE	DESCRIPTION	BY
A	07/22/24	ISSUED FOR REVIEW	HT
B	10/15/24	REVISED	BP
C	11/05/24	REVISED	BP

I HEREBY CERTIFY THAT THESE DRAWINGS WERE PREPARED BY ME OR UNDER MY DIRECT SUPERVISION AND CONTROL, AND TO THE BEST OF MY KNOWLEDGE AND BELIEF COMPLY WITH THE REQUIREMENTS OF ALL APPLICABLE CODES.

TASK NAME
WILC-FR03

TASK DESCRIPTION
**FIBER OPTIC CONDUIT
PLACEMENT**

PROJECT AREA
LACROSSE, WI, USA

SHEET SCALE
N.T.S.

SHEET TITLE
MAP

GRID NUMBER

SHEET NUMBER
MAP-1



metronet
 3701 COMMUNICATIONS WAY
 EVANSVILLE, IN, 47715



1100 E. WOODFIELD ROAD, SUITE 500
 SCHAUMBURG, ILLINOIS 60173
 TEL: 847-908-8400
 COA# 3620-11
 www.fullerton-us.com

MATCHLINE - SHEET C-02

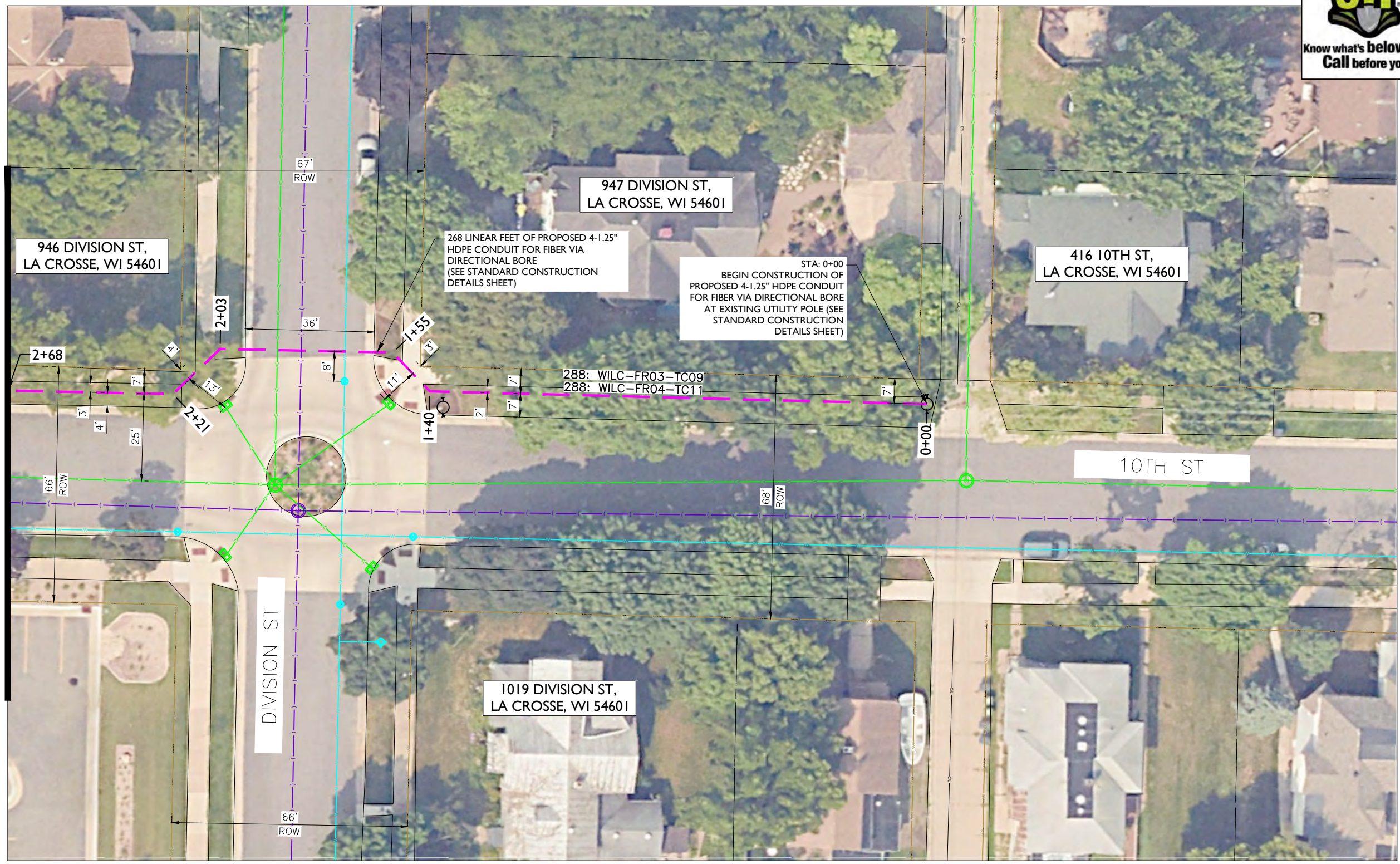

268 LINEAR FEET OF PROPOSED 4-1.25" HDPE CONDUIT FOR FIBER VIA DIRECTIONAL BORE (SEE STANDARD CONSTRUCTION DETAILS SHEET)

STA: 0+00
 BEGIN CONSTRUCTION OF PROPOSED 4-1.25" HDPE CONDUIT FOR FIBER VIA DIRECTIONAL BORE AT EXISTING UTILITY POLE (SEE STANDARD CONSTRUCTION DETAILS SHEET)

288: WILC-FR03-TC09
 288: WILC-FR04-TC11

REV	DATE	DESCRIPTION	BY
A	07/22/24	ISSUED FOR REVIEW	HT
B	10/15/24	REVISED	BP
C	11/05/24	REVISED	BP

I HEREBY CERTIFY THAT THESE DRAWINGS WERE PREPARED BY ME OR UNDER MY DIRECT SUPERVISION AND CONTROL, AND TO THE BEST OF MY KNOWLEDGE AND BELIEF COMPLY WITH THE REQUIREMENTS OF ALL APPLICABLE CODES.

TASK NAME
WILC-FR03

TASK DESCRIPTION
FIBER OPTIC CONDUIT PLACEMENT

PROJECT AREA
 LACROSSE, WI, USA

SHEET SCALE
 1" = 30'-0"

SHEET TITLE
DESIGN LAYOUT

GRID NUMBER
 SHEET NUMBER
C-01

- NOTE:
- PROPOSED CONDUIT SHALL AVOID EXISTING SEEPAGE BEDS
 - BURY AT 24" MIN. UNDER SOFT SURFACE
 - BURY AT 36" MIN. UNDER HARD SURFACE
 - MAINTAIN 1' FROM BACK OF SIDEWALK, WHEN APPLICABLE.

NOTE:
 PRIOR TO CONSTRUCTION ALL STREET LIGHT WIRING MUST BE PROPERLY LOCATED.

NOTE:
 RIGHT-OF-WAY LINE SHOWN PER INFORMATION PROVIDED IN GIS FILE OBTAINED FROM LA CROSSE CITY

NOTE:
 METRONET WILL MAINTAIN 5' CLEARANCE FROM EXISTING MANHOLES, VALVES, AND FIRE HYDRANTS & 7.5' CLEARANCE FROM STORM AND SANITARY INLETS, MANHOLES AND CATCH BASINS.





metronet
3701 COMMUNICATIONS WAY
EVANSVILLE, IN, 47715



1100 E. WOODFIELD ROAD, SUITE 500
SCHAUMBURG, ILLINOIS 60173
TEL: 847-908-8400
COA# 3620-11
www.fullerton-us.com

MATCHLINE - SHEET C-03

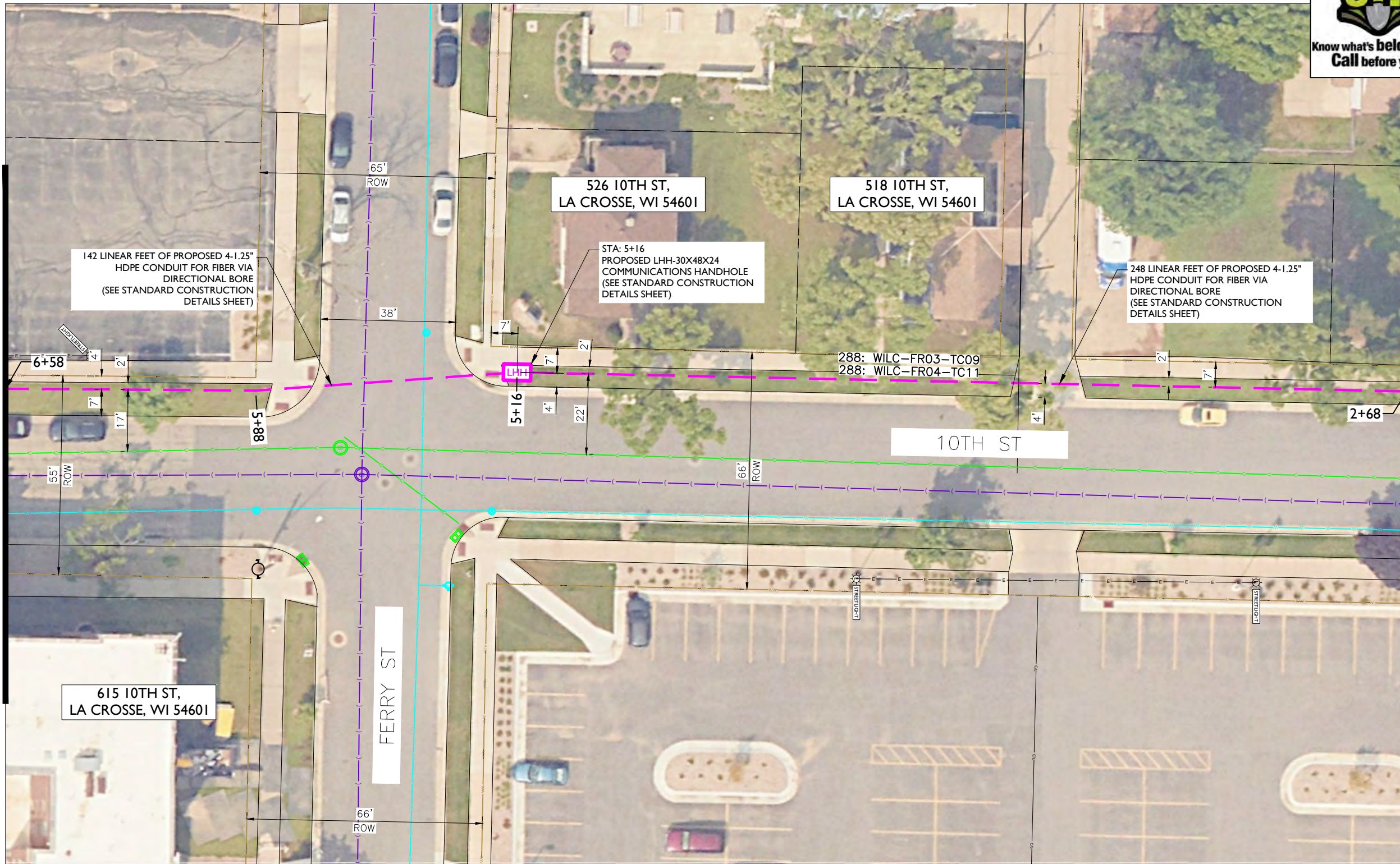

MATCHLINE - SHEET C-01

REV	DATE	DESCRIPTION	BY
A	07/22/24	ISSUED FOR REVIEW	HT
B	10/15/24	REVISED	BP
C	11/05/24	REVISED	BP

I HEREBY CERTIFY THAT THESE DRAWINGS WERE PREPARED BY ME OR UNDER MY DIRECT SUPERVISION AND CONTROL, AND TO THE BEST OF MY KNOWLEDGE AND BELIEF COMPLY WITH THE REQUIREMENTS OF ALL APPLICABLE CODES.

TASK NAME
WILC-FR03

TASK DESCRIPTION
FIBER OPTIC CONDUIT PLACEMENT

PROJECT AREA
LACROSSE, WI, USA

SHEET SCALE
1" = 30'-0"

SHEET TITLE
DESIGN LAYOUT

GRID NUMBER

SHEET NUMBER
C-02

- NOTE:
- PROPOSED CONDUIT SHALL AVOID EXISTING SEEPAGE BEDS
 - BURY AT 24" MIN. UNDER SOFT SURFACE
 - BURY AT 36" MIN. UNDER HARD SURFACE
 - MAINTAIN 1' FROM BACK OF SIDEWALK, WHEN APPLICABLE.

NOTE:
PRIOR TO CONSTRUCTION ALL STREET LIGHT WIRING MUST BE PROPERLY LOCATED.

NOTE:
RIGHT-OF-WAY LINE SHOWN PER INFORMATION PROVIDED IN GIS FILE OBTAINED FROM LA CROSSE CITY

NOTE:
METRONET WILL MAINTAIN 5' CLEARANCE FROM EXISTING MANHOLES, VALVES, AND FIRE HYDRANTS & 7.5' CLEARANCE FROM STORM AND SANITARY INLETS, MANHOLES AND CATCH BASINS.





metronet
 3701 COMMUNICATIONS WAY
 EVANSVILLE, IN, 47715



1100 E. WOODFIELD ROAD, SUITE 500
 SCHAUMBURG, ILLINOIS 60173
 TEL: 847-908-8400
 COA# 3620-11
 www.fullerton-us.com

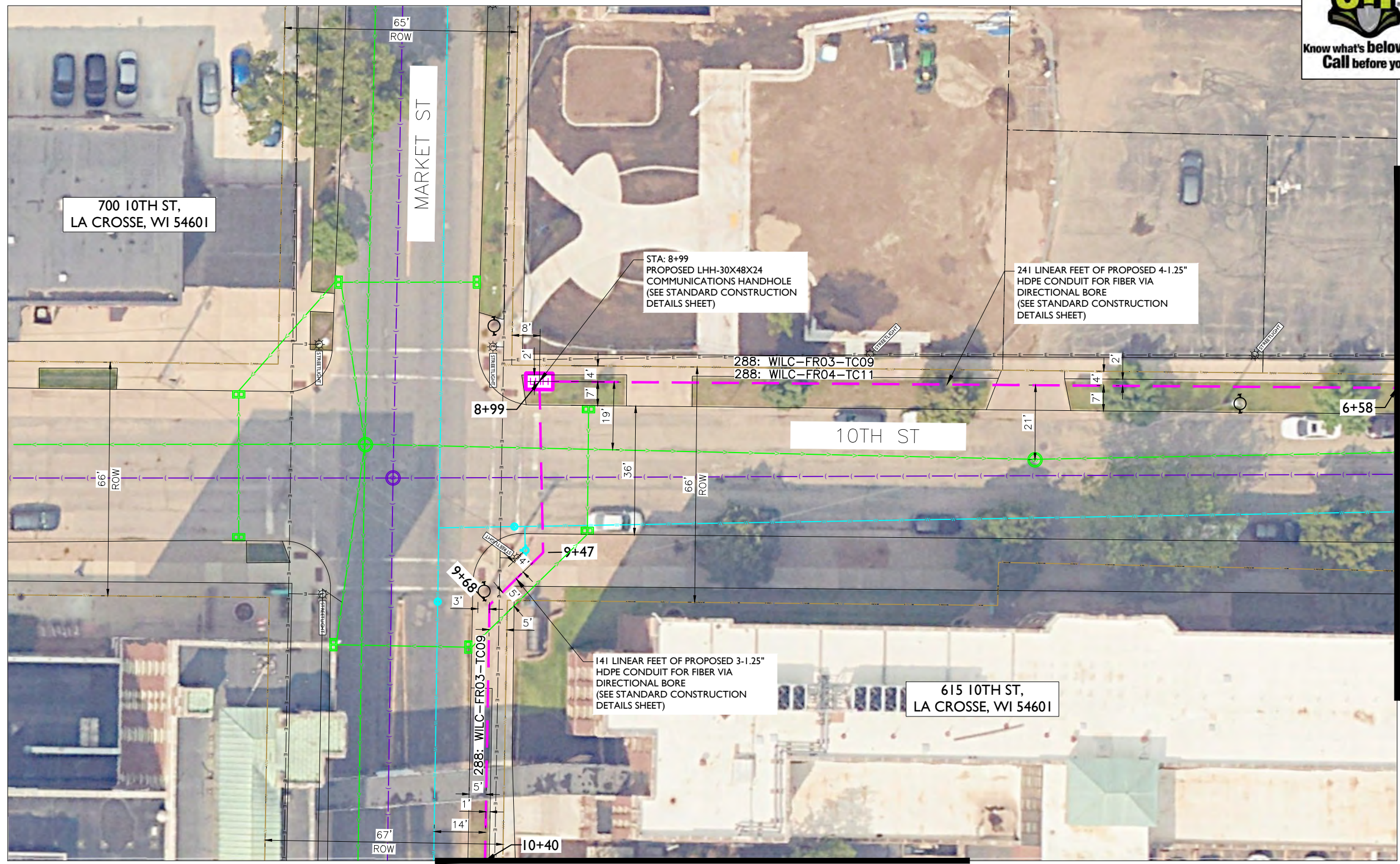

MATCHLINE - SHEET C-02

MATCHLINE - SHEET C-04

REV	DATE	DESCRIPTION	BY
A	07/22/24	ISSUED FOR REVIEW	HT
B	10/15/24	REVISED	BP
C	11/05/24	REVISED	BP

I HEREBY CERTIFY THAT THESE DRAWINGS WERE PREPARED BY ME OR UNDER MY DIRECT SUPERVISION AND CONTROL, AND TO THE BEST OF MY KNOWLEDGE AND BELIEF COMPLY WITH THE REQUIREMENTS OF ALL APPLICABLE CODES.

TASK NAME
WILC-FR03

TASK DESCRIPTION
FIBER OPTIC CONDUIT PLACEMENT

PROJECT AREA
 LACROSSE, WI, USA

SHEET SCALE
 1" = 30'-0"

SHEET TITLE
DESIGN LAYOUT

GRID NUMBER

SHEET NUMBER
C-03

- NOTE:
- PROPOSED CONDUIT SHALL AVOID EXISTING SEEPAGE BEDS
 - BURY AT 24" MIN. UNDER SOFT SURFACE
 - BURY AT 36" MIN. UNDER HARD SURFACE
 - MAINTAIN 1' FROM BACK OF SIDEWALK, WHEN APPLICABLE.

NOTE:
 PRIOR TO CONSTRUCTION ALL STREET LIGHT WIRING MUST BE PROPERLY LOCATED.

NOTE:
 RIGHT-OF-WAY LINE SHOWN PER INFORMATION PROVIDED IN GIS FILE OBTAINED FROM LA CROSSE CITY

NOTE:
 METRONET WILL MAINTAIN 5' CLEARANCE FROM EXISTING MANHOLES, VALVES, AND FIRE HYDRANTS & 7.5' CLEARANCE FROM STORM AND SANITARY INLETS, MANHOLES AND CATCH BASINS.





metronet
3701 COMMUNICATIONS WAY
EVANSVILLE, IN, 47715



1100 E. WOODFIELD ROAD, SUITE 500
SCHAUMBURG, ILLINOIS 60173
TEL: 847-908-8400
COA# 3620-11
www.fullerton-us.com

MATCHLINE - SHEET C-03

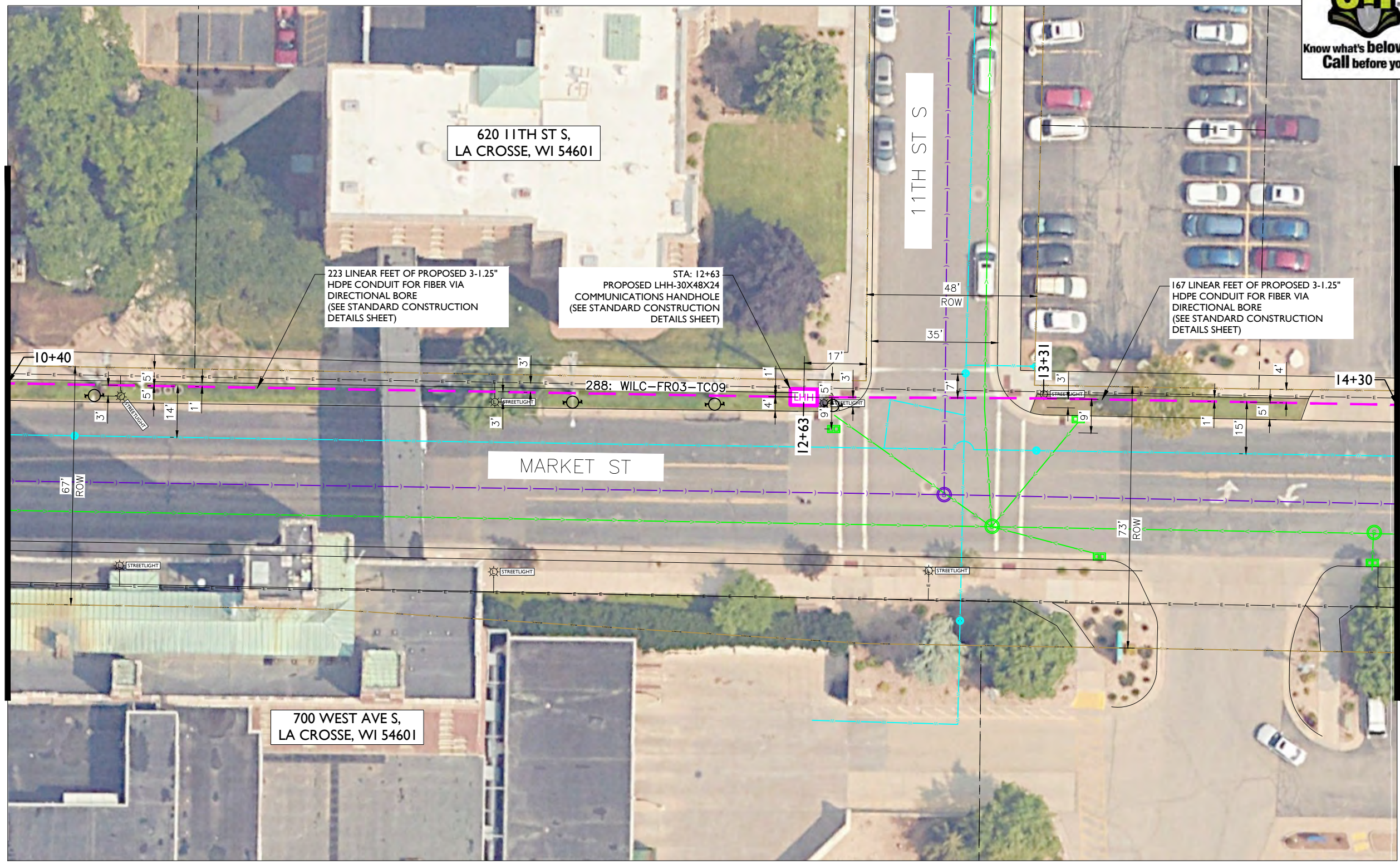

MATCHLINE - SHEET C-05

REV	DATE	DESCRIPTION	BY
A	07/22/24	ISSUED FOR REVIEW	HT
B	10/15/24	REVISED	BP
C	11/05/24	REVISED	BP

I HEREBY CERTIFY THAT THESE DRAWINGS WERE PREPARED BY ME OR UNDER MY DIRECT SUPERVISION AND CONTROL, AND TO THE BEST OF MY KNOWLEDGE AND BELIEF COMPLY WITH THE REQUIREMENTS OF ALL APPLICABLE CODES.

TASK NAME
WILC-FR03

TASK DESCRIPTION
FIBER OPTIC CONDUIT PLACEMENT

PROJECT AREA
LACROSSE, WI, USA

SHEET SCALE
1" = 30'-0"

SHEET TITLE
DESIGN LAYOUT

GRID NUMBER

SHEET NUMBER
C-04

- NOTE:
- PROPOSED CONDUIT SHALL AVOID EXISTING SEEPAGE BEDS
 - BURY AT 24" MIN. UNDER SOFT SURFACE
 - BURY AT 36" MIN. UNDER HARD SURFACE
 - MAINTAIN 1' FROM BACK OF SIDEWALK, WHEN APPLICABLE.

NOTE:
PRIOR TO CONSTRUCTION ALL STREET LIGHT WIRING MUST BE PROPERLY LOCATED.

NOTE:
RIGHT-OF-WAY LINE SHOWN PER INFORMATION PROVIDED IN GIS FILE OBTAINED FROM LA CROSSE CITY

NOTE:
METRONET WILL MAINTAIN 5' CLEARANCE FROM EXISTING MANHOLES, VALVES, AND FIRE HYDRANTS & 7.5' CLEARANCE FROM STORM AND SANITARY INLETS, MANHOLES AND CATCH BASINS.





metronet
3701 COMMUNICATIONS WAY
EVANSVILLE, IN, 47715



1100 E. WOODFIELD ROAD, SUITE 500
SCHAUMBURG, ILLINOIS 60173
TEL: 847-908-8400
COA# 3620-11
www.fullerton-us.com

REV	DATE	DESCRIPTION	BY
A	07/22/24	ISSUED FOR REVIEW	HT
B	10/15/24	REVISED	BP
C	11/05/24	REVISED	BP

I HEREBY CERTIFY THAT THESE DRAWINGS WERE PREPARED BY ME OR UNDER MY DIRECT SUPERVISION AND CONTROL, AND TO THE BEST OF MY KNOWLEDGE AND BELIEF COMPLY WITH THE REQUIREMENTS OF ALL APPLICABLE CODES.

TASK NAME
WILC-FR03

TASK DESCRIPTION
FIBER OPTIC CONDUIT PLACEMENT

PROJECT AREA
LACROSSE, WI, USA

SHEET SCALE
1" = 30'-0"

SHEET TITLE
DESIGN LAYOUT

GRID NUMBER

SHEET NUMBER
C-05

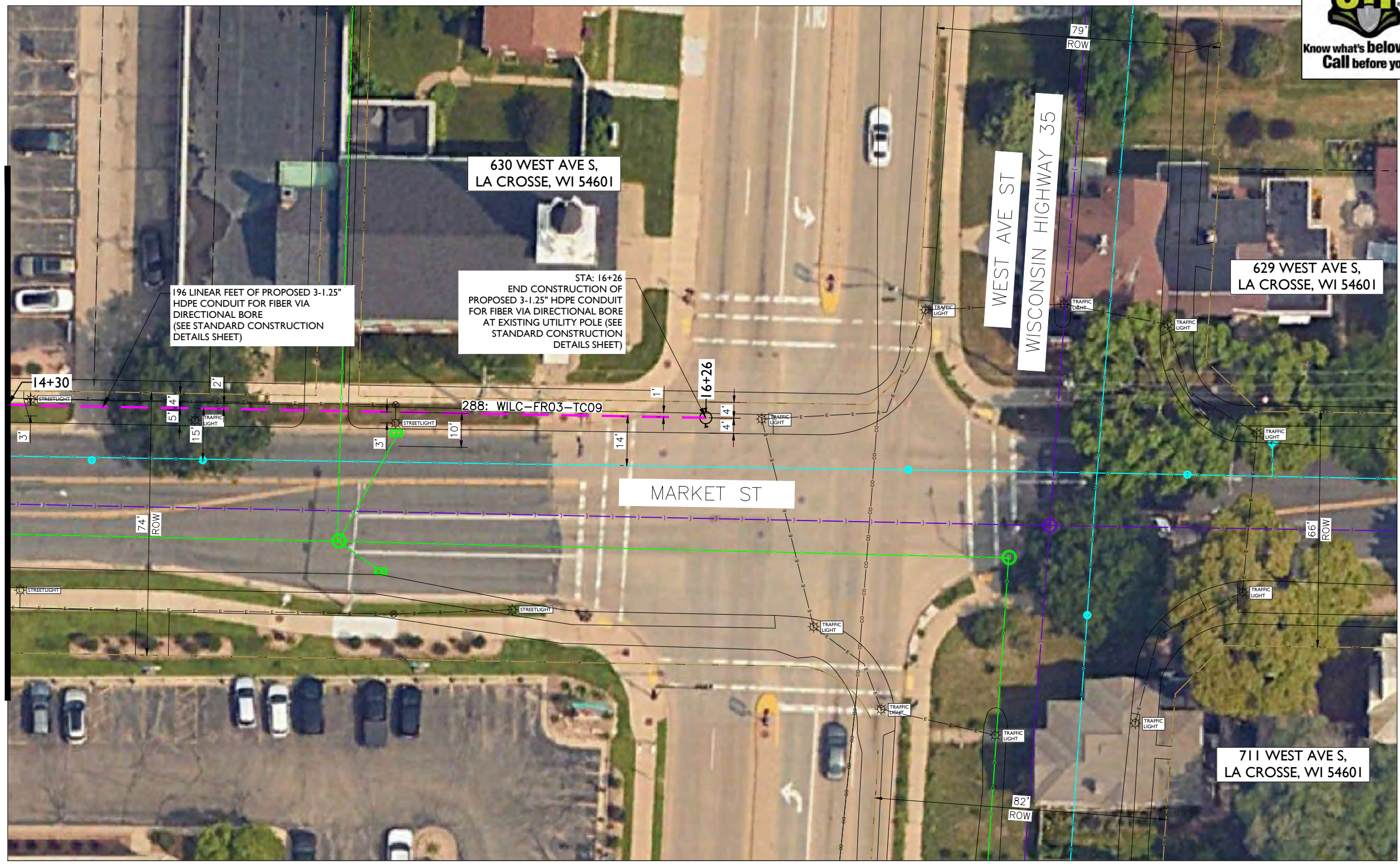

MATCHLINE - SHEET C-04

- NOTE:
- PROPOSED CONDUIT SHALL AVOID EXISTING SEEPAGE BEDS
 - BURY AT 24" MIN. UNDER SOFT SURFACE
 - BURY AT 36" MIN. UNDER HARD SURFACE
 - MAINTAIN 1' FROM BACK OF SIDEWALK, WHEN APPLICABLE.

NOTE:
PRIOR TO CONSTRUCTION ALL STREET LIGHT WIRING MUST BE PROPERLY LOCATED.

NOTE:
PRIOR TO CONSTRUCTION ALL TRAFFIC SIGNAL WIRING AT THE INTERSECTION MUST BE PROPERLY LOCATED.

NOTE:
RIGHT-OF-WAY LINE SHOWN PER INFORMATION PROVIDED IN GIS FILE OBTAINED FROM LA CROSSE CITY

NOTE:
METRONET WILL MAINTAIN 5' CLEARANCE FROM EXISTING MANHOLES, VALVES, AND FIRE HYDRANTS & 7.5' CLEARANCE FROM STORM AND SANITARY INLETS, MANHOLES AND CATCH BASINS.

ADDITIONAL NOTES:

1. EXCEPT AS OTHERWISE NOTED, CONTRACTOR SHALL MAINTAIN A MINIMUM OF 24 INCHES OF SEPARATION FROM EXISTING UTILITIES.
2. CONTRACTOR SHALL POT HOLE EACH UTILITY TO DETERMINE SIZE, LOCATION, AND DEPTH PRIOR TO CROSSING.
3. CONTRACTOR IS CAUTIONED TO PROTECT SEWER MANHOLES, CATCH BASINS, LATERALS AND INLETS.
4. CONTRACTOR WILL PROVIDE BARRICADING TO INSURE CORRECT TRAFFIC CONTROL WHILE MAINTAINING VEHICULAR TRAFFIC AT ALL TIMES.
5. RESTORATION TO BE IN COMPLIANCE WITH APPLICABLE PERMITTING AGENCIES.
6. BONDING AND GROUNDING PER NESC.

PUBLIC UTILITY NOTE:

CONTRACTOR SHALL NOTIFY ALL PUBLIC UTILITY COMPANIES (GAS, ELECTRIC, TELEPHONE, SEWER, WATER, ETC) PRIOR TO COMMENCING ANY CONSTRUCTION. THESE COMPANIES WILL LOCATE, ON THE GROUND, THE LOCATION OF ALL CONDUITS, DUCTS, UNDERGROUND PIPING, ETC., ADJOINING & CROSSING PROPOSED CONSTRUCTION.

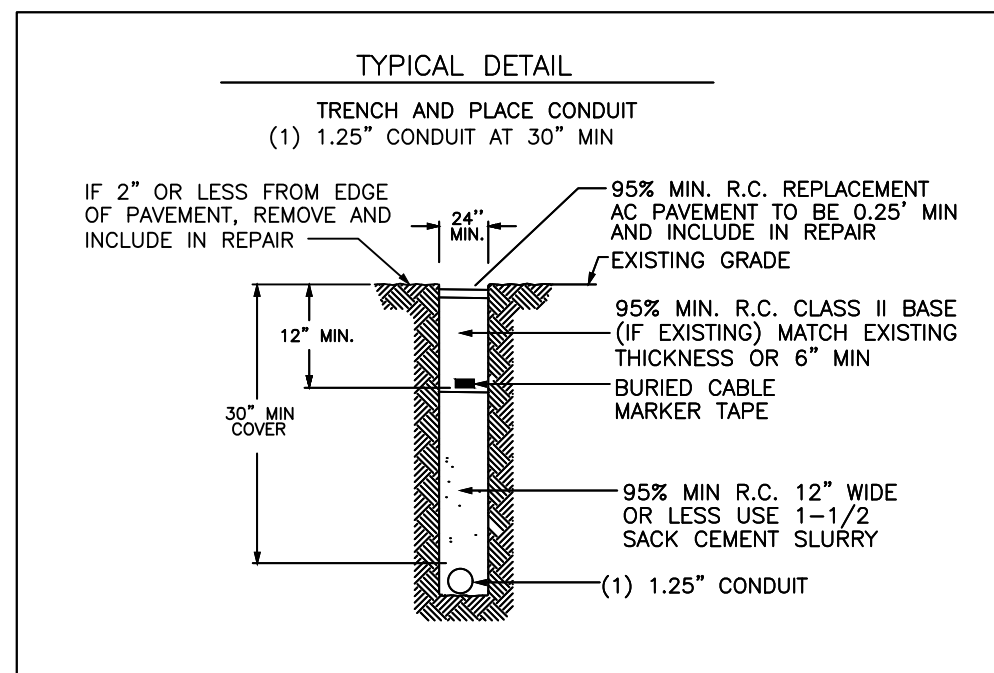
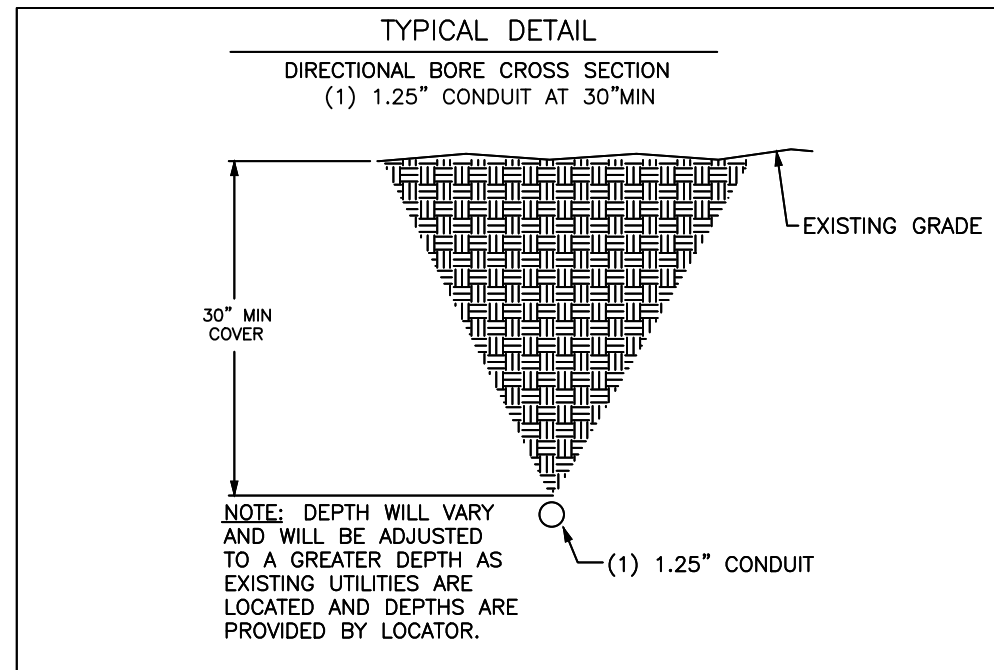

REV	DATE	DESCRIPTION	BY
A	07/22/24	ISSUED FOR REVIEW	HT
B	10/15/24	REVISED	BP
C	11/05/24	REVISED	BP

I HEREBY CERTIFY THAT THESE DRAWINGS WERE PREPARED BY ME OR UNDER MY DIRECT SUPERVISION AND CONTROL, AND TO THE BEST OF MY KNOWLEDGE AND BELIEF COMPLY WITH THE REQUIREMENTS OF ALL APPLICABLE CODES.

TASK NAME

WILC-FR03

TASK DESCRIPTION

FIBER OPTIC CONDUIT PLACEMENT

PROJECT AREA

LACROSSE, WI, USA

SHEET SCALE

N.T.S.

SHEET TITLE

DETAILS

GRID NUMBER

SHEET NUMBER

D-1

BODY SPECIFICATIONS

Cover Weight 26 lbs [12 kg]
Pit Weight 63 lbs [29 kg]
Assembled Weight 89 lbs [41 kg]

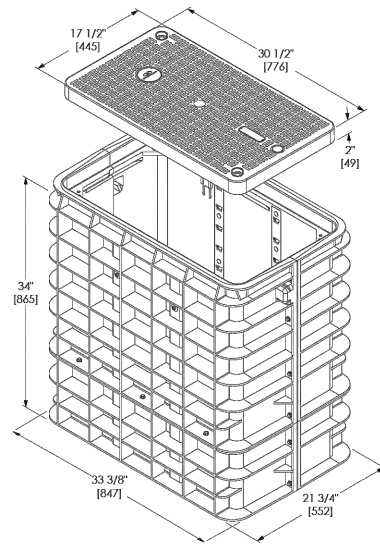

ADDITIONAL BODY DEPTHS

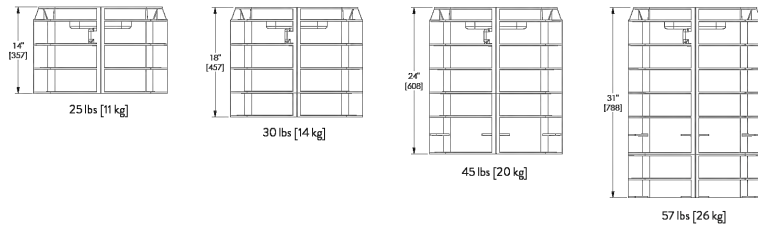

BODY SPECIFICATIONS

Cover Weight 50 lbs [23 kg]
Pit Weight 82 lbs [37 kg]
Assembled Weight 132 lbs [60 kg]

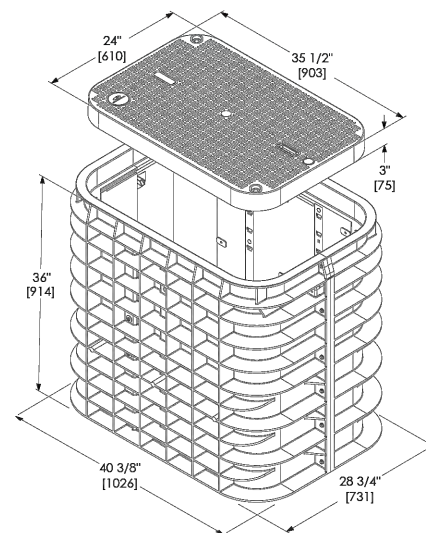
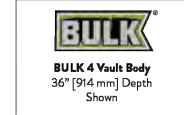

ADDITIONAL BODY DEPTHS

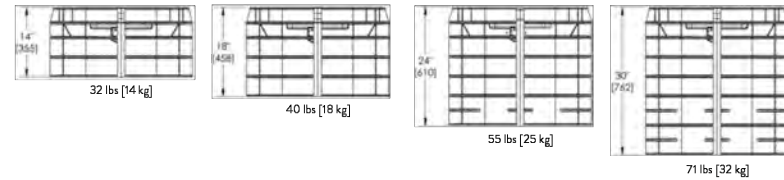

BODY SPECIFICATIONS

Cover Weight (Split 1/2 Cover) 50 lbs [23 kg]
Pit Weight 129 lbs [59 kg]
Assembled Weight 229 lbs [105 kg]

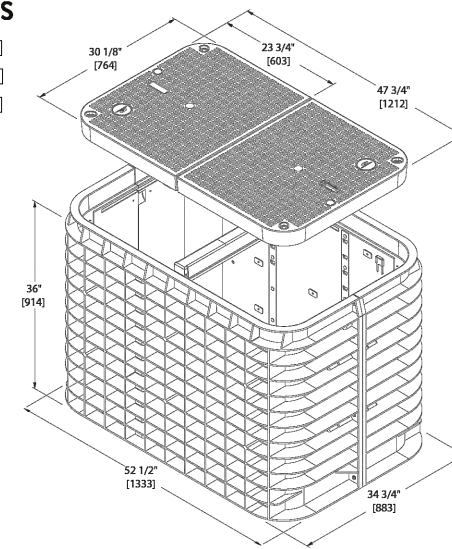
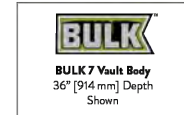

ADDITIONAL BODY DEPTHS

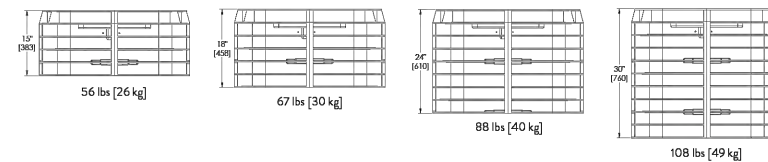

REV	DATE	DESCRIPTION	BY
A	07/22/24	ISSUED FOR REVIEW	HT
B	10/15/24	REVISED	BP
C	11/05/24	REVISED	BP

I HEREBY CERTIFY THAT THESE DRAWINGS WERE PREPARED BY ME OR UNDER MY DIRECT SUPERVISION AND CONTROL, AND TO THE BEST OF MY KNOWLEDGE AND BELIEF COMPLY WITH THE REQUIREMENTS OF ALL APPLICABLE CODES.

TASK NAME

WILC-FR03

TASK DESCRIPTION
FIBER OPTIC CONDUIT
PLACEMENT

PROJECT AREA
LACROSSE, WI, USA

SHEET SCALE
N.T.S.

SHEET TITLE
DETAILS

GRID NUMBER

SHEET NUMBER
D-2

SGLB-0 NEW SIGNATURE SERIES GRADE LEVEL BOX WITH **SELFLOCK** PROTECTION



SELFLOCK

The New Signature Series SGLB High Density Polyethylene (HDPE) grade level box line come standard with Logo Disk and the Patented **SELFLOCK** automatic locking mechanism.

FEATURES

- 13" (330mm) Depth
- No bolts to be lost, misplaced, or not installed back into the unit

- Captive bolt device, that opens with a ¼ turn
- Press/Push lid closed, and it will automatically lock in place (with an audible "click")
- Protects your investment, and ensures the needed protection for your network
- Eliminates the risk of lids floating off, being throw by lawnmowers (i.e. reduces potentially liability)

SIMPLE AND WORRY FREE PROTECTION



DIMENSIONS

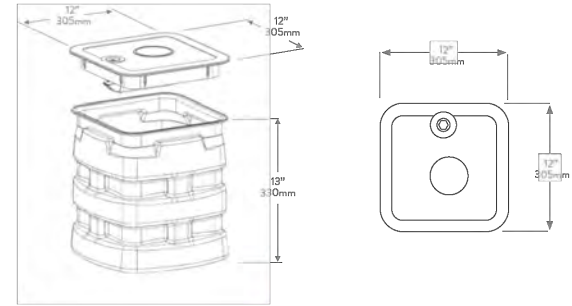

WORLDWIDE HEADQUARTERS: Channell Commercial Corporation, Rockwall, TX, United States • Tel 800.423.1863 • Fax 951.296.2322
 CANADA: Channell Canada, Inc., Mississauga, ON, Canada • Tel 905.565.1700 • Fax 905.565.8282
 EUROPE, MIDDLE EAST, AFRICA: Channell Ltd., Dartford, United Kingdom • Tel 44.1322.312590 • Fax 44.1322.508490
 AUSTRALIA, ASIA, PACIFIC RIM: Channell Pty. Ltd., Seven Hills, NSW, Australia • Tel 61.2.8884.4111 • Fax 61.2.8814.8841

www.channell.com

All specifications subject to change without notice. © 2022 Channell Commercial Corporation. All rights reserved.

040822 FR1

SGLB-2 SIGNATURE SERIES GRADE LEVEL BOX WITH **SELFLOCK** PROTECTION



SELFLOCK

The Signature Series SGLB-2 High Density Polyethylene (HDPE) grade level box line comes standard with Customizable Logo Disk and the Patented **SELFLOCK** automatic locking mechanism.

FEATURES

- Designed for Greenbelt/Pedestrian applications
- Captive bolt device, that opens with a ¼ turn

- No bolts to be lost, misplaced, or not installed back into the unit
- Press/Push lid closed, and it will automatically lock in place (with an audible "click")
- Secondary lock option
- Temporary drop port
- Protects your investment, and ensures the needed protection for your network
- Eliminates the risk of lids floating off, being thrown by lawnmowers (i.e. reduces potential liability)

SIMPLE AND WORRY FREE PROTECTION

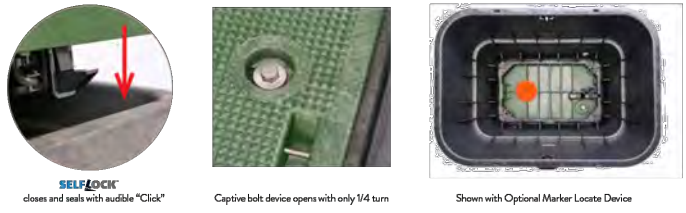

DIMENSIONS

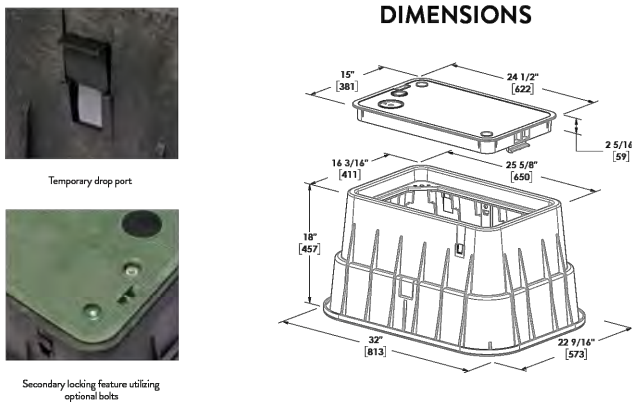

www.channell.com

All specifications subject to change without notice. © 2024 Channell Commercial Corporation. All rights reserved.

022624

metronet
 3701 COMMUNICATIONS WAY
 EVANSVILLE, IN, 47715

Fullerton
 DESIGN DEVELOP CONSTRUCT

1100 E. WOODFIELD ROAD, SUITE 500
 SCHAUMBURG, ILLINOIS 60173
 TEL: 847-908-8400
 COA# 3620-11
 www.fullerton-us.com

REV	DATE	DESCRIPTION	BY
A	07/22/24	ISSUED FOR REVIEW	HT
B	10/15/24	REVISED	BP
C	11/05/24	REVISED	BP

I HEREBY CERTIFY THAT THESE DRAWINGS WERE PREPARED BY ME OR UNDER MY DIRECT SUPERVISION AND CONTROL, AND TO THE BEST OF MY KNOWLEDGE AND BELIEF COMPLY WITH THE REQUIREMENTS OF ALL APPLICABLE CODES.

TASK NAME

WILC-FR03

TASK DESCRIPTION
FIBER OPTIC CONDUIT PLACEMENT

PROJECT AREA

LACROSSE, WI, USA

SHEET SCALE

N.T.S.

SHEET TITLE

DETAILS

GRID NUMBER

SHEET NUMBER

D-3

NOTES:

1. CALL FOR LOCATES AT LEAST 72 HOURS IN ADVANCE OF ANY CONSTRUCTION FOR MARKINGS.
2. FOR LABEL AND TAG INFORMATION SEE DRAWING OSP 16.
3. THE VAULT W/ BOTTOM ENTRY ELEVATION VIEW SHOWN BELOW ONLY INDICATES THE BACK FILL REQUIREMENTS NECESSARY FOR VAULTS PLACED IN SIDEWALKS, ETC. (WHERE THEY NEED TO COMPLY WITH ADA REQUIREMENTS). TO ENSURE COMPLIANCE WITH CURRENT ADA REQUIREMENTS, THE HEIGHT OF THE BACK FILL IS SHOWN HELD DOWN TO ALLOW CONCRETE TO FLOW DOWN AND AROUND THE LIFTING LUGS/BOLTS WHICH WILL SERVE AS DOWELS INTO THE FINISHED CONCRETE SLAB.

ADA REQUIREMENTS:

SURFACE LEVEL CRITERIA: NO HEIGHT DIFFERENTIALS WITH A RISE GREATER THAN 1/4" IN HEIGHT. EXCEPTIONS: A HEIGHT DIFFERENTIAL BETWEEN 1/4" AND 1/2" IS ACCEPTABLE IF IT IS BEVELLED AT A 2:1 SLOPE, OR A HEIGHT DIFFERENTIAL GREATER THAN 1/2" IS ACCEPTABLE IF IT IS RAMPED WITH A SLOPE OF 8.33% (1V:12H) OR LESS.

UTILITY COVERS SHALL HAVE A SLOP RESISTANT TOP, AS MUCH AS POSSIBLE, AND MEET CHANGES IN LEVEL CRITERIA AS STATED ABOVE.

LIFT HOLES FOR UTILITY COVERS SHALL NOT HAVE AN OPENING GREATER THAN 1/2". PLUGGING OF HOLES GREATER THAN 1/2" WITH A MATERIAL APPROVED BY THE ENGINEER IS ACCEPTABLE AS LONG AS IT IS FLUSH WITH THE COVER SURFACE.

A LEVEL PEDESTRIAN ACCESS ROUTE (PAR) OR WALKWAY SHALL BE PROVIDED ACROSS COMMERCIAL AND RESIDENTIAL ENTRANCES, MEETING THE FOLLOWING CRITERIA:

- THE WALKWAY IS AT MINIMUM 3' WIDE.
- CROSS SLOPE OF WALKWAY IS 2% OR LESS.
- WALKWAY IS AT THE SAME GRADE AS THE ADJACENT ROADWAY.
- THE WALKWAY DOES NOT HAVE TO BE MARKED, BUT PROVIDES A STRAIGHT LINE BETWEEN THE ADJOINING SIDEWALKS OR RAMPS.
- THERE IS NOT AN ABRUPT TRANSITION FROM THE DRIVEWAY TO THE ROADWAY FOR VEHICLES, I.E. VEHICLES WILL NOT BOTTOM OUT WHEN DRIVING OVER THE TRANSITION.

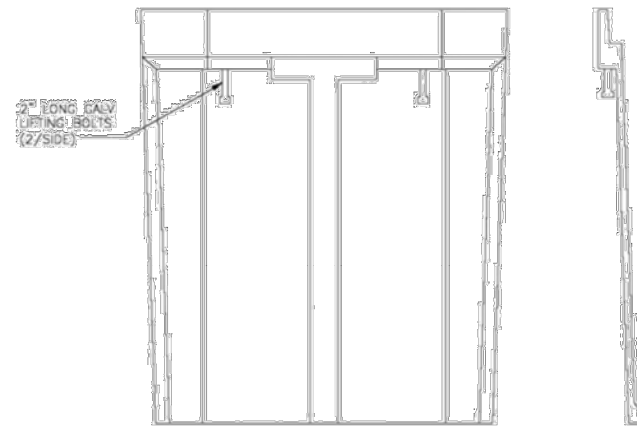
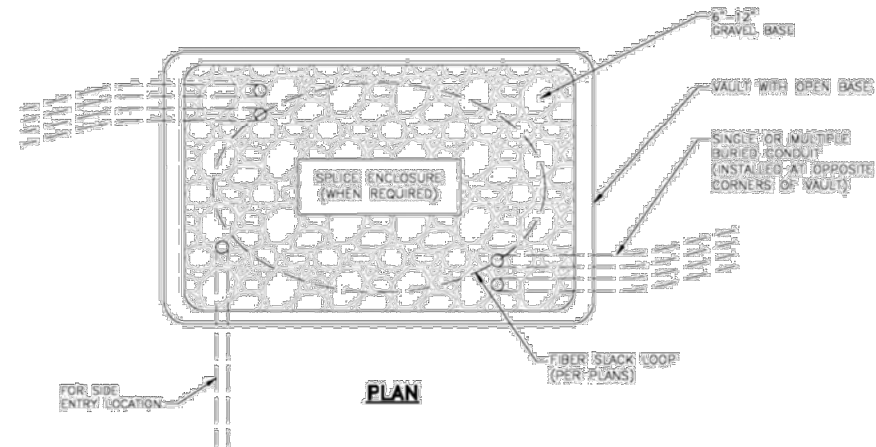

SIDE VIEW

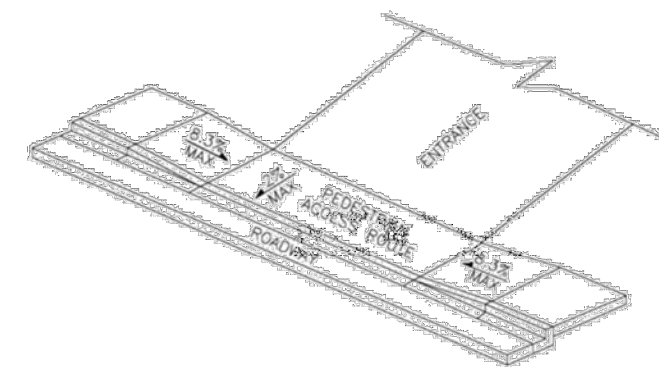

PEDESTRIAN ACCESS ROUTE

NOTE:

1. ENCLOSURES, BOXES AND COVERS ARE REQUIRED TO MEET OR EXCEED ALL TESTS PROVISIONS OF THE MOST CURRENT ANSI/SCSI 77-2007 "SPECIFICATIONS FOR UNDERGROUND INTEGRITY" FOR TIER 15 OR BETTER.

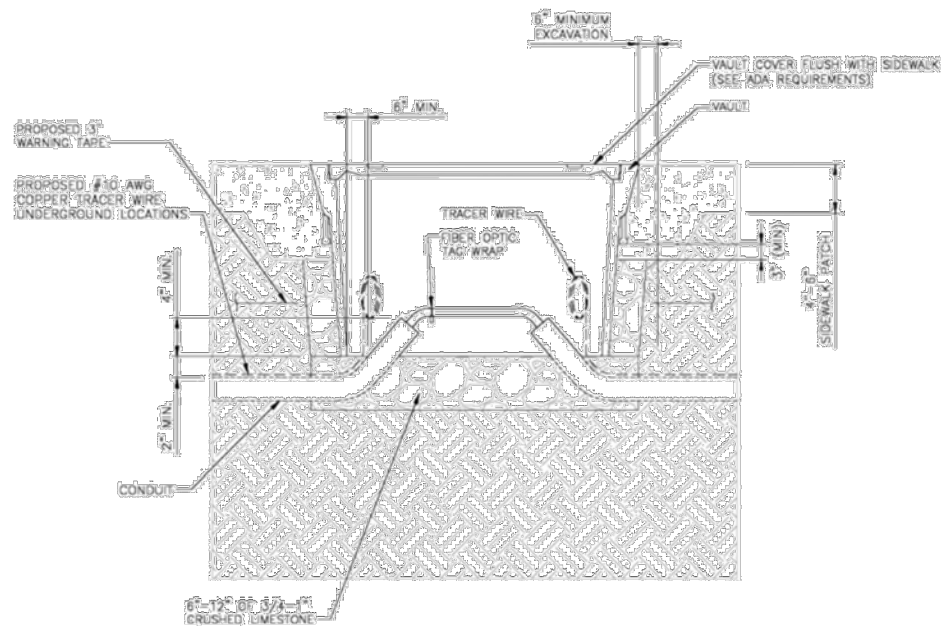

VAULT W/ BOTTOM ENTRY

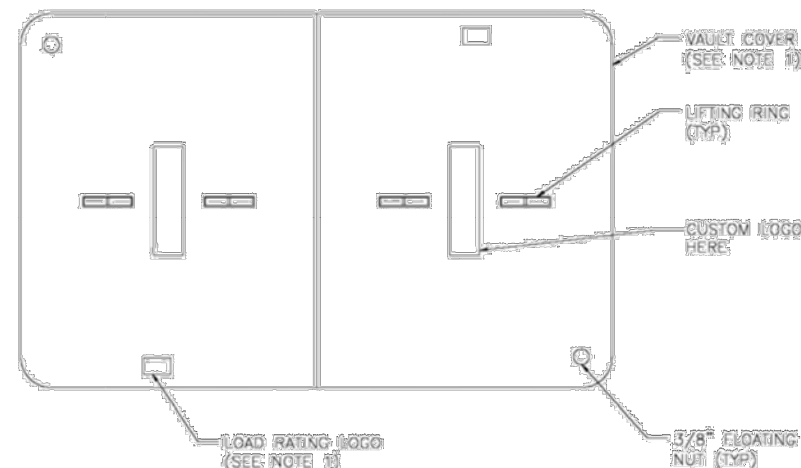

VAULT LID

REV	DATE	DESCRIPTION	BY
A	07/22/24	ISSUED FOR REVIEW	HT
B	10/15/24	REVISED	BP
C	11/05/24	REVISED	BP

I HEREBY CERTIFY THAT THESE DRAWINGS WERE PREPARED BY ME OR UNDER MY DIRECT SUPERVISION AND CONTROL, AND TO THE BEST OF MY KNOWLEDGE AND BELIEF COMPLY WITH THE REQUIREMENTS OF ALL APPLICABLE CODES.

TASK NAME	WILC-FR03
TASK DESCRIPTION	FIBER OPTIC CONDUIT PLACEMENT
PROJECT AREA	LACROSSE, WI, USA
SHEET SCALE	N.T.S.
SHEET TITLE	DETAILS
GRID NUMBER	
SHEET NUMBER	D-4

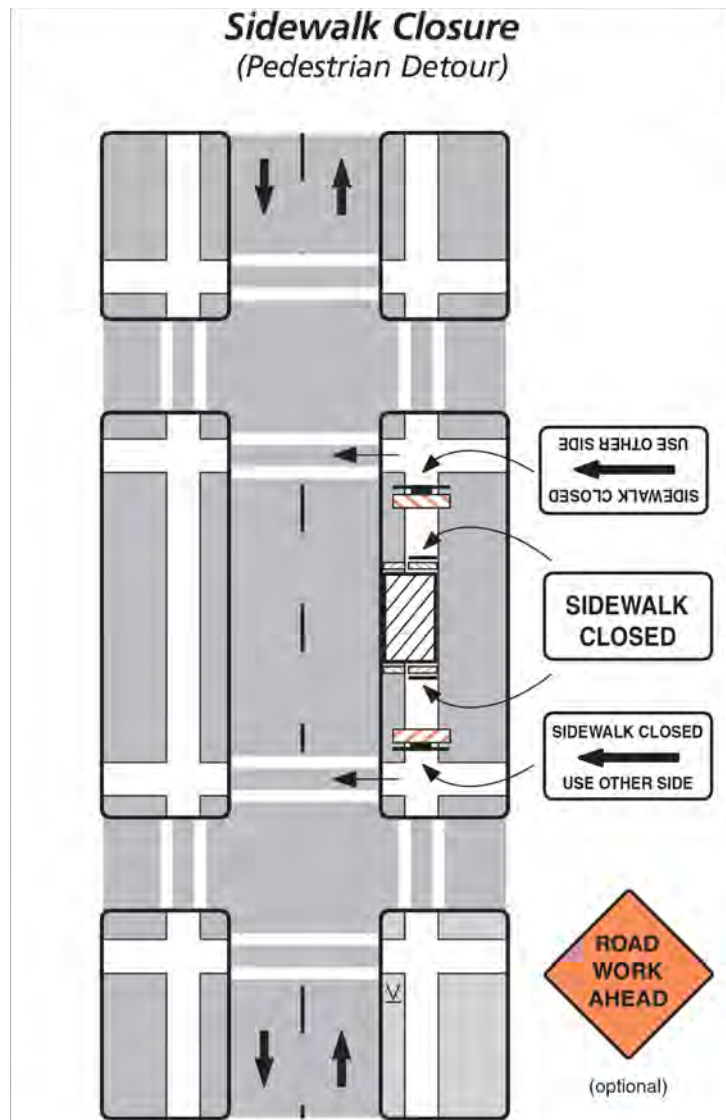

- Notes**
1. Additional advance warning may be necessary.
 2. Only the traffic control devices related to pedestrians are shown. Other devices may be needed to control traffic on the streets such as lane closure signs, ROAD NARROWS or LANE NARROWS signs.
 3. For nighttime closures, Type A flashing warning lights may be used on barricades supporting signs and closing walkways.
 4. Audible devices should be considered to alert pedestrians with visual disabilities of closings and crosswalk changes.

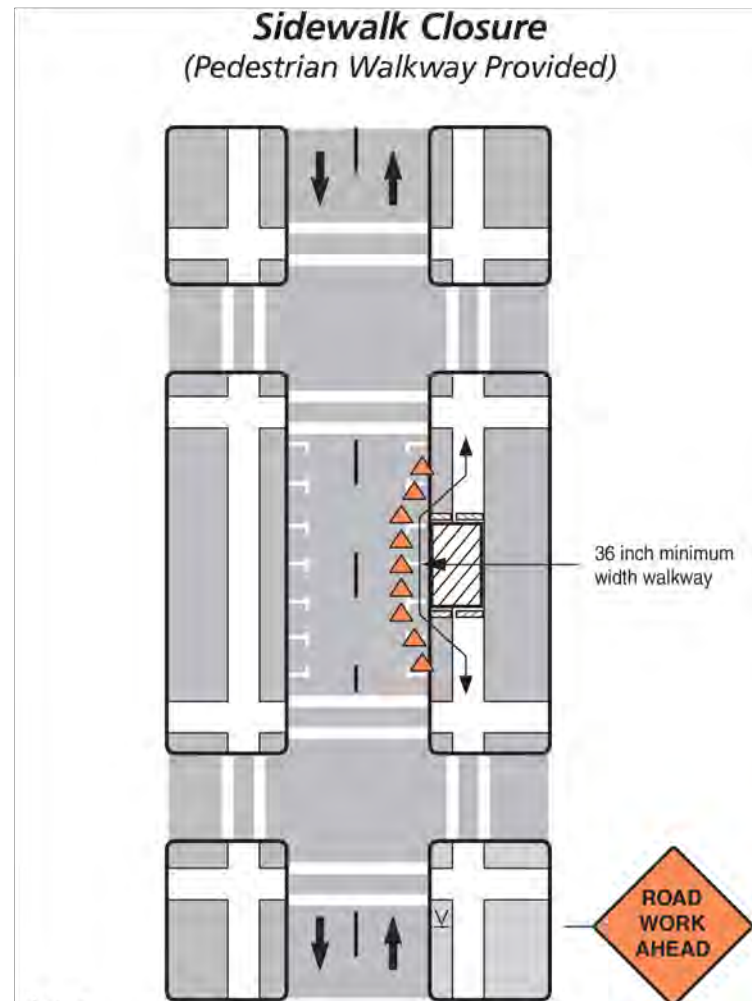

- Notes**
1. Additional advance warning may be necessary.
 2. Only the traffic control devices related to pedestrians are shown. Other devices such as lane closure signs, ROAD NARROWS or LANE NARROWS signs may be needed to control traffic on the streets.
 3. For nighttime closures, Type A flashing warning lights may be used on barricades supporting signs and closing walkways. Type C or Type D steady-burn lights may be used on channelizing devices separating the temporary walkway from vehicular traffic.
 4. Where high speeds are likely, a barrier should separate the temporary walkway from vehicular traffic. Refer to Section 6D.01 of Part 6 of the MUTCD for information on barriers.
 5. Signs may be placed along a temporary walkway to guide pedestrians; for example, Keep Right or Keep Left signs.
 6. Pedestrian walkways should be ADA accessible (i.e., ramps, surfaces).

metronet
 3701 COMMUNICATIONS WAY
 EVANSVILLE, IN, 47715

Fullerton
 DESIGN DEVELOP CONSTRUCT
 1100 E. WOODFIELD ROAD, SUITE 500
 SCHAUMBURG, ILLINOIS 60173
 TEL: 847-908-8400
 COA# 3620-11
 www.fullerton-us.com

REV	DATE	DESCRIPTION	BY
A	07/22/24	ISSUED FOR REVIEW	HT
B	10/15/24	REVISED	BP
C	11/05/24	REVISED	BP

I HEREBY CERTIFY THAT THESE DRAWINGS WERE PREPARED BY ME OR UNDER MY DIRECT SUPERVISION AND CONTROL, AND TO THE BEST OF MY KNOWLEDGE AND BELIEF COMPLY WITH THE REQUIREMENTS OF ALL APPLICABLE CODES.

TASK NAME	WILC-FR03
TASK DESCRIPTION	FIBER OPTIC CONDUIT PLACEMENT
PROJECT AREA	LACROSSE, WI, USA
SHEET SCALE	N.T.S.
SHEET TITLE	TRAFFIC CONTROL STANDARD DETAILS
GRID NUMBER	
SHEET NUMBER	TCP-1

Work Beyond the Shoulder

Speed Limit (mph)	Sign Spacing A (ft)
25-30	200
35-40	350
45-55	500
Expressway/Freeway	1000

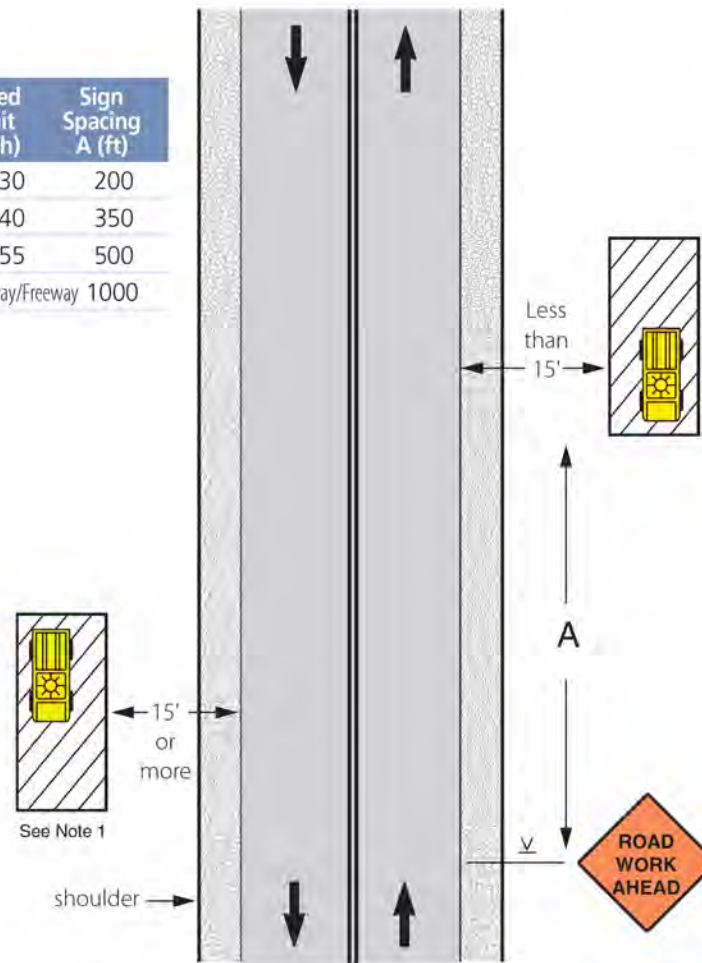

Notes

- The warning sign may be omitted where the work area is behind a guard rail, more than 2' behind a curb, 30' or more from the edge of a freeway/expressway, or 15' or more from the edge of any other roadway.
- For short-term, short-duration, or mobile operations, the warning sign may be omitted if a vehicle with activated high intensity light is used. On State Roads, the warning sign can be omitted if the duration of work is less than 60 minutes and activated high intensity lights are used.
- The ROAD WORK AHEAD sign may be replaced with other appropriate signs such as SHOULDER WORK, UTILITY WORK AHEAD, SURVEY CREW, MOWING AHEAD or WORKERS.

Work on Shoulder or Parking Lane on Two-Lane Two-Way Road

Speed Limit (mph)	Sign Spacing A (ft)	Sign Spacing B (ft)	Shoulder Taper (ft) 10' shoulder	Buffer (ft)
25	200	400	35	155
30	200	400	50	200
35	350	700	70	250
40	350	700	90	305
45	500	1500	150	360
50	500	1500	170	425
55	500	1500	185	495

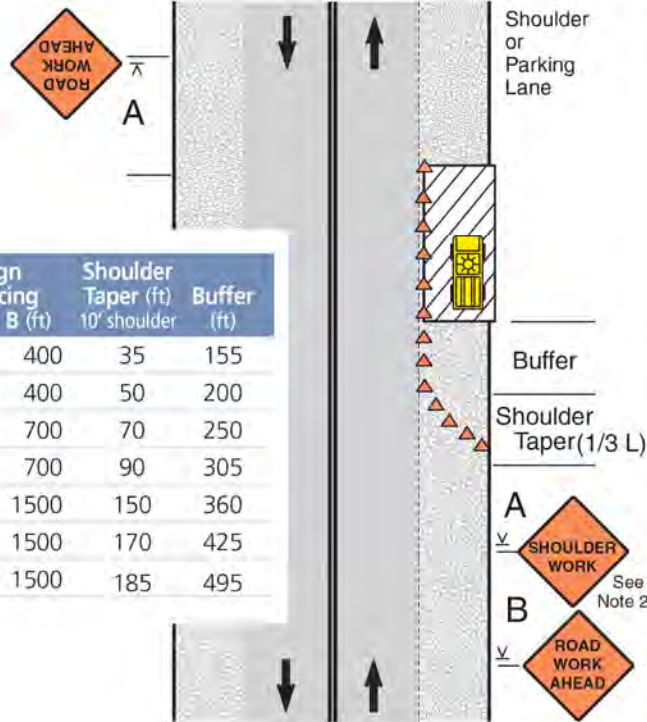

Notes

- Encroachment into the traffic lane is allowable, but a 10-foot minimum travel lane width should be maintained. A lane closure should be considered if there is encroachment on roads with speeds greater than 35 mph, or for other conditions where workers, equipment, or the work activity would benefit from the lateral buffer (see pages 22 and 23).
- If there is encroachment into the traffic lane, a ROAD NARROWS sign may be used instead of SHOULDER WORK. For roads with low volume, the SHOULDER WORK or ROAD NARROWS sign can be omitted.
- For short duration work, the channelizing devices may be omitted if a vehicle with activated high intensity lights is used. For short duration work with no lane encroachment, the signs may also be omitted.
- WORKERS, UTILITY WORK AHEAD, SHOULDER WORK AHEAD, or SURVEY CREW signs may be used instead of SHOULDER WORK or ROAD WORK AHEAD.
- When work area is at least 2' from traffic lane on roads with low volume and speeds of 35 mph or less, the sign on opposite side can be omitted.

Shoulder or Parking Lane Closed on Divided or One-Way Roadway

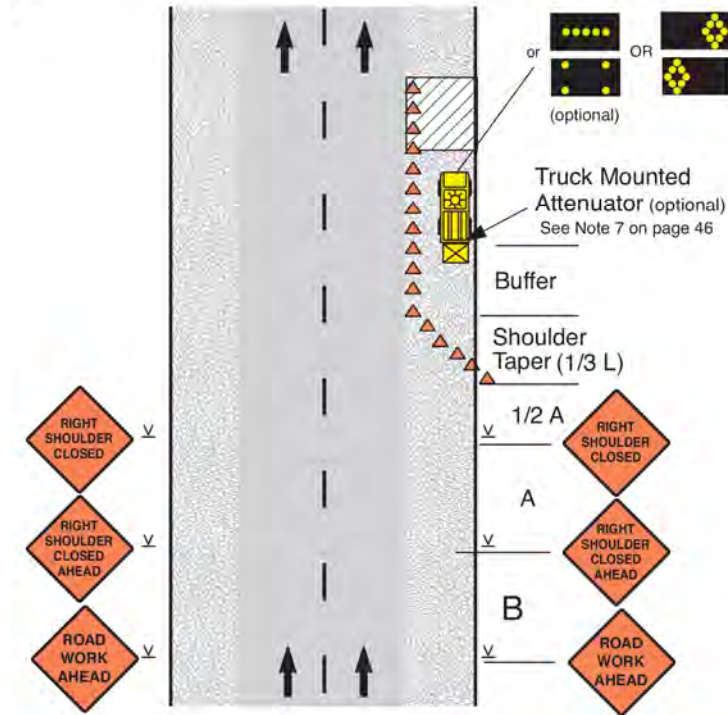

Notes

- SHOULDER CLOSED signs should be used on limited-access highways where there is no opportunity for disabled vehicles to pull off the traveled way.
- For short-term stationary work, one SHOULDER CLOSED warning sign can be omitted.
- For short duration work, the channelizing devices can be omitted if a vehicle with activated high intensity lights is used. For short duration work with no lane encroachment, the signs can also be omitted.
- UTILITY WORK AHEAD, SURVEY CREW or WORKERS signs can be used instead of the ROAD WORK AHEAD signs shown.
- If the parking lane is used as a traffic lane follow the lane closure layout. See page 32.

Speed Limit (mph)	Sign Spacing A (ft)	Sign Spacing B (ft)	Shoulder Taper (ft) 10' shoulder	Buffer (ft)
35	350	350	70	250
40	350	350	90	305
45	1000	1000	150	360
50	1000	1000	170	425
55	1000	1000	185	495
60	1000	1500	200	570
65	1000	1500	220	645
70	1000	1500	235	730

REV	DATE	DESCRIPTION	BY
A	07/22/24	ISSUED FOR REVIEW	HT
B	10/15/24	REVISED	BP
C	11/05/24	REVISED	BP

I HEREBY CERTIFY THAT THESE DRAWINGS WERE PREPARED BY ME OR UNDER MY DIRECT SUPERVISION AND CONTROL, AND TO THE BEST OF MY KNOWLEDGE AND BELIEF COMPLY WITH THE REQUIREMENTS OF ALL APPLICABLE CODES.

TASK NAME	WILC-FR03
-----------	------------------

TASK DESCRIPTION	FIBER OPTIC CONDUIT PLACEMENT
------------------	--------------------------------------

PROJECT AREA	LACROSSE, WI, USA
--------------	-------------------

SHEET SCALE	N.T.S.
-------------	--------

SHEET TITLE	TRAFFIC CONTROL STANDARD DETAILS
-------------	---

GRID NUMBER	
-------------	--

SHEET NUMBER	TCP-2
--------------	--------------

Work in Travel Lane
(Maintaining Two-Way Traffic, 35 mph or Less)

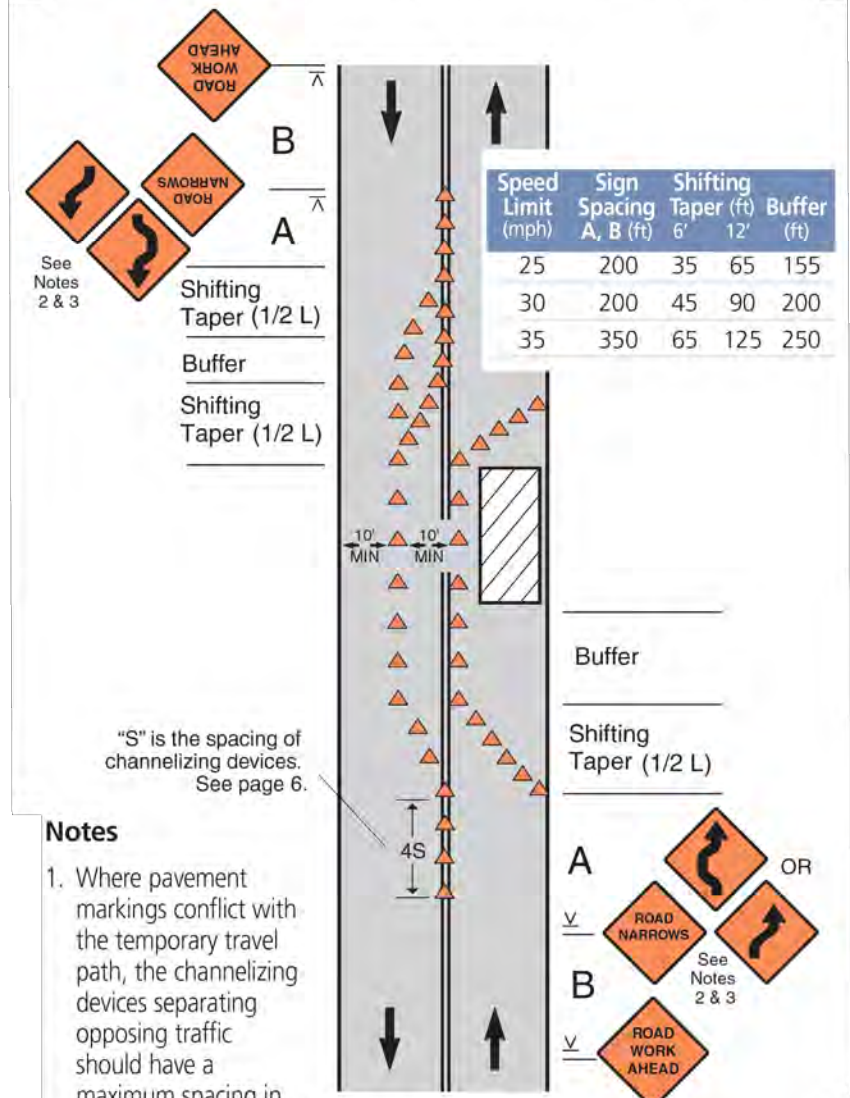

Notes

- Where pavement markings conflict with the temporary travel path, the channelizing devices separating opposing traffic should have a maximum spacing in feet of 1/2 the speed limit in mph.
- The ROAD NARROWS or Reverse Curve/Turn sign is optional on roads with low volume or where the lane shift requires only a minor deviation in the travel path. The Reverse Curve/Turn sign is appropriate for larger deviations in the travel path.
- If the tangent is more than 600', the Reverse Curve/Turn sign should be used instead of the Double Reverse Curve sign.
- If speeds are 30 mph or less, Reverse Turn signs shall be used instead of Reverse Curve.

Work in Travel Lane on Divided or One-Way Roadway
(35 mph or Less)

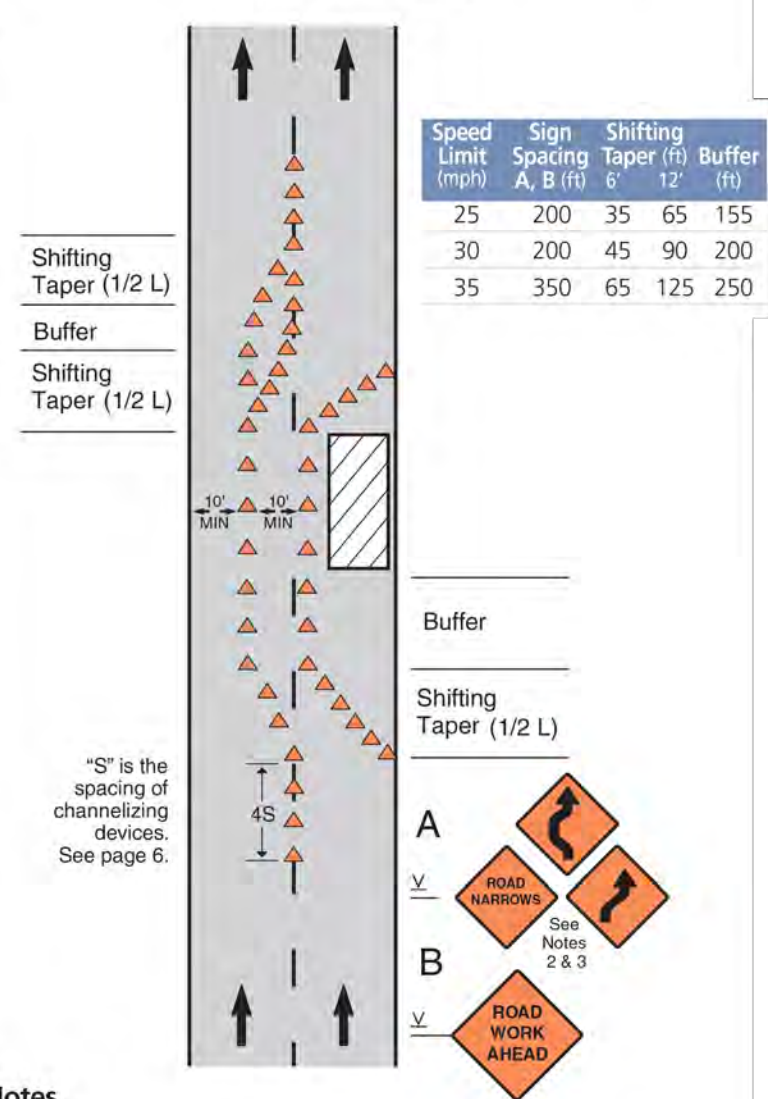

Notes

- Where pavement markings conflict with the temporary travel path, the channelizing devices separating opposing traffic should have a maximum spacing in feet of 1/2 the speed limit in mph.
- If the tangent is more than 600 feet, the Reverse Curve/Turn sign should be used instead of the Double Reverse Curve sign.
- If speeds are 30 mph or less, Reverse Turn signs shall be used instead of Reverse Curve.

REV	DATE	DESCRIPTION	BY
A	07/22/24	ISSUED FOR REVIEW	HT
B	10/15/24	REVISED	BP
C	11/05/24	REVISED	BP

I HEREBY CERTIFY THAT THESE DRAWINGS WERE PREPARED BY ME OR UNDER MY DIRECT SUPERVISION AND CONTROL, AND TO THE BEST OF MY KNOWLEDGE AND BELIEF COMPLY WITH THE REQUIREMENTS OF ALL APPLICABLE CODES.

TASK NAME
WILC-FR03

TASK DESCRIPTION
FIBER OPTIC CONDUIT PLACEMENT

PROJECT AREA
LACROSSE, WI, USA

SHEET SCALE
N.T.S.

SHEET TITLE
TRAFFIC CONTROL STANDARD DETAILS

GRID NUMBER

SHEET NUMBER
TCP-3

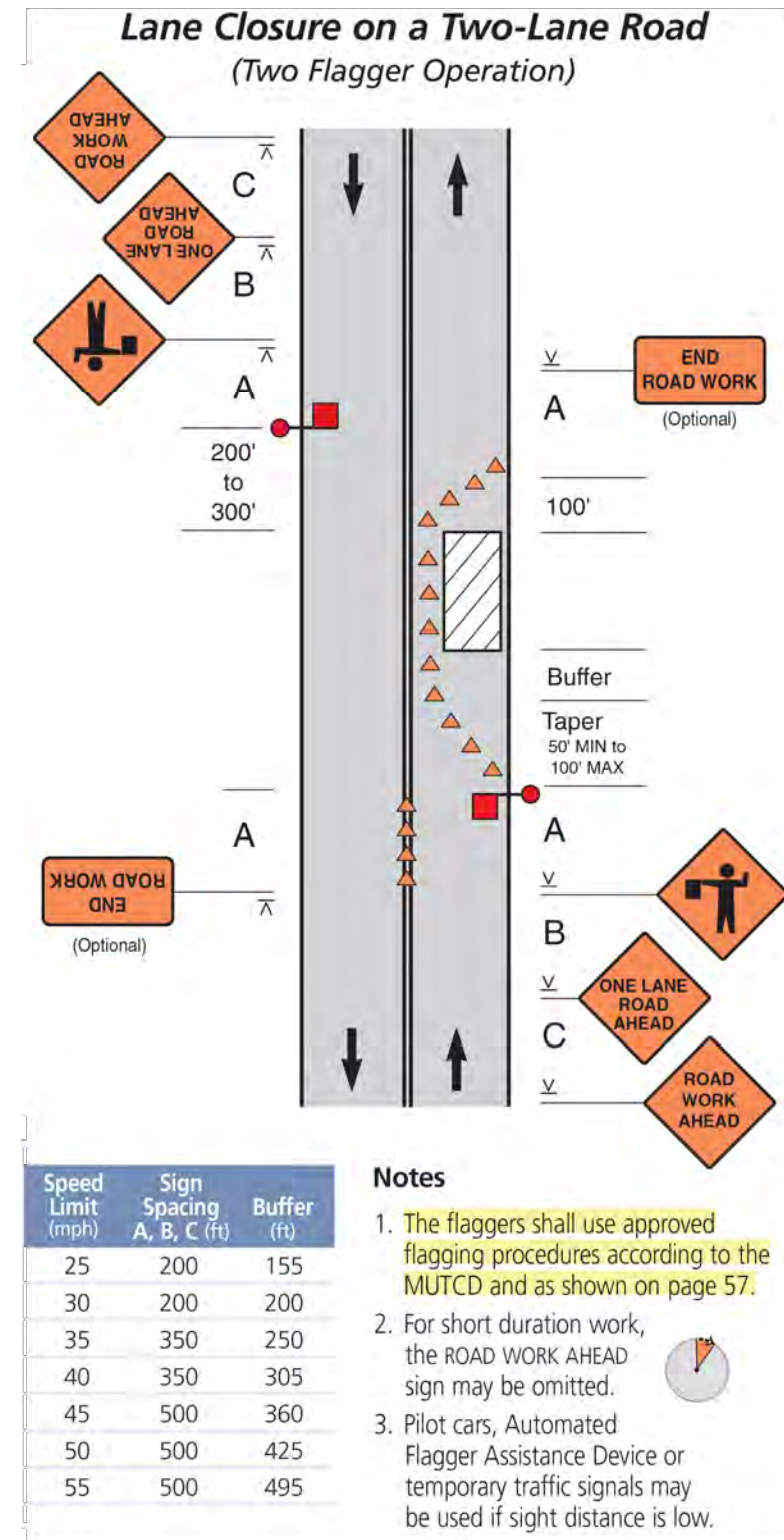
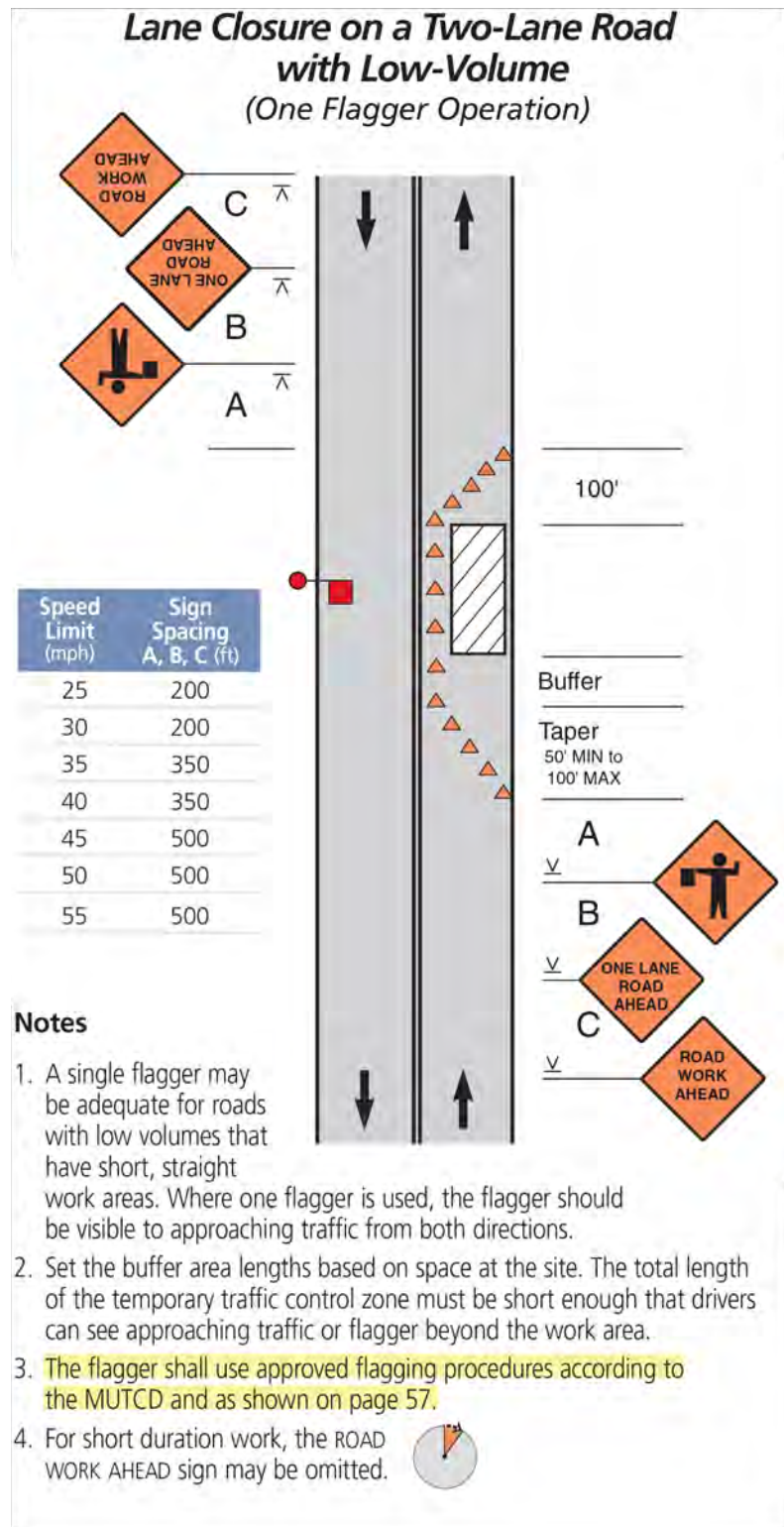

REV	DATE	DESCRIPTION	BY
A	07/22/24	ISSUED FOR REVIEW	HT
B	10/15/24	REVISED	BP
C	11/05/24	REVISED	BP

I HEREBY CERTIFY THAT THESE DRAWINGS WERE PREPARED BY ME OR UNDER MY DIRECT SUPERVISION AND CONTROL, AND TO THE BEST OF MY KNOWLEDGE AND BELIEF COMPLY WITH THE REQUIREMENTS OF ALL APPLICABLE CODES.

TASK NAME	WILC-FR03
TASK DESCRIPTION	FIBER OPTIC CONDUIT PLACEMENT
PROJECT AREA	LACROSSE, WI, USA
SHEET SCALE	N.T.S.
SHEET TITLE	TRAFFIC CONTROL STANDARD DETAILS
GRID NUMBER	
SHEET NUMBER	TCP-4

Lane Closure on a Two-Lane Local Road with Low Volume (with Yield Sign)

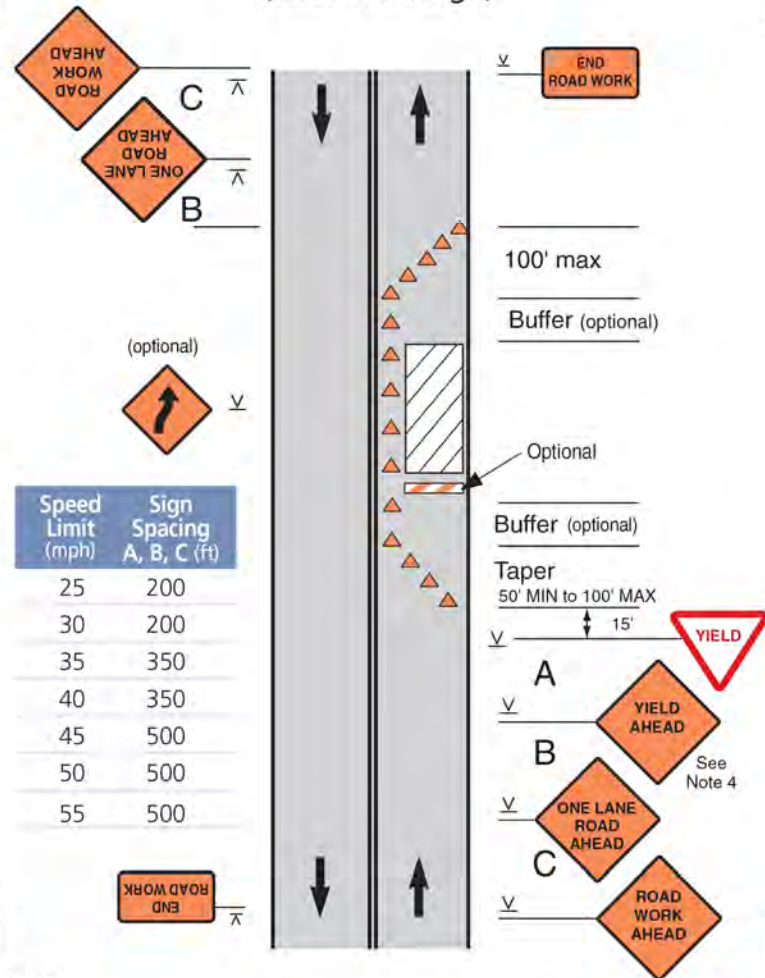

Notes

1. This layout may be used when volume is low, work area short, sight distance good, and traffic can see beyond the work area.
2. This layout shall not be used on a state highway, connecting highway or any other roadway officially designated as a "through" highway.
3. The YIELD sign shall only be used with permission from the authority having jurisdiction over the roadway.
4. Set the buffer area lengths based on space at the site. The total length of the temporary traffic control zone must be short enough that drivers can see approaching traffic beyond the work area.
5. YIELD AHEAD symbol sign may be used.

Lane Closure on a Two-Lane Road with Stop Signs (ADT Less Than 1000)

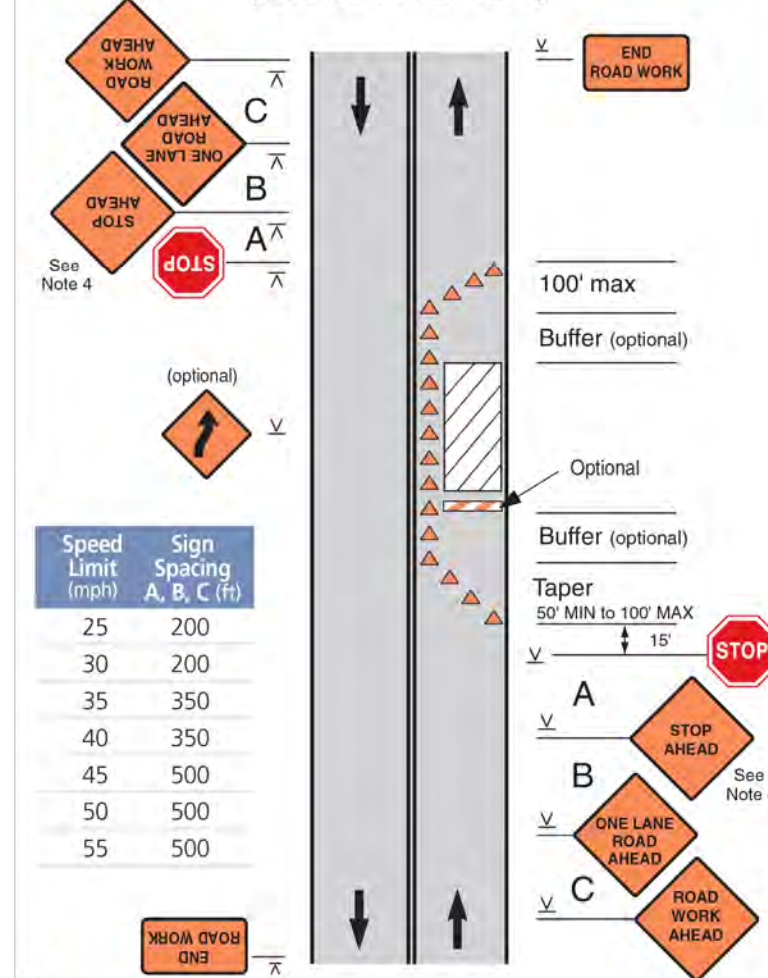

Notes

1. Consider using this layout when ADT is less than 1000, work area is short, sight distance good, and traffic can see beyond the work area. It could be appropriate for ADT above 1000 if limited to off-peak hours.
2. STOP signs shall only be used with permission from the authority having jurisdiction over the roadway.
3. Determine buffer area length based on space at the site. Total length of the temporary traffic control zone must be short enough that drivers from both directions can see approaching traffic beyond the work area.
4. Stop Ahead symbol sign may be used.
5. On State Roads use the appropriate WisDOT Standard design detail or consult with a WisDOT Regional Work Zone engineer.

REV	DATE	DESCRIPTION	BY
A	07/22/24	ISSUED FOR REVIEW	HT
B	10/15/24	REVISED	BP
C	11/05/24	REVISED	BP

I HEREBY CERTIFY THAT THESE DRAWINGS WERE PREPARED BY ME OR UNDER MY DIRECT SUPERVISION AND CONTROL, AND TO THE BEST OF MY KNOWLEDGE AND BELIEF COMPLY WITH THE REQUIREMENTS OF ALL APPLICABLE CODES.

TASK NAME
WILC-FR03

TASK DESCRIPTION
FIBER OPTIC CONDUIT PLACEMENT

PROJECT AREA
LACROSSE, WI, USA

SHEET SCALE
N.T.S.

SHEET TITLE
TRAFFIC CONTROL STANDARD DETAILS

GRID NUMBER

SHEET NUMBER
TCP-5

REV	DATE	DESCRIPTION	BY
A	07/22/24	ISSUED FOR REVIEW	HT
B	10/15/24	REVISED	BP
C	11/05/24	REVISED	BP

I HEREBY CERTIFY THAT THESE DRAWINGS WERE PREPARED BY ME OR UNDER MY DIRECT SUPERVISION AND CONTROL, AND TO THE BEST OF MY KNOWLEDGE AND BELIEF COMPLY WITH THE REQUIREMENTS OF ALL APPLICABLE CODES.

TASK NAME

WILC-FR03

TASK DESCRIPTION
FIBER OPTIC CONDUIT PLACEMENT

PROJECT AREA
LACROSSE, WI, USA

SHEET SCALE
N.T.S.

SHEET TITLE
TRAFFIC CONTROL STANDARD DETAILS

GRID NUMBER

SHEET NUMBER
TCP-6

Surveying Along Centerline of Road with Low Volume

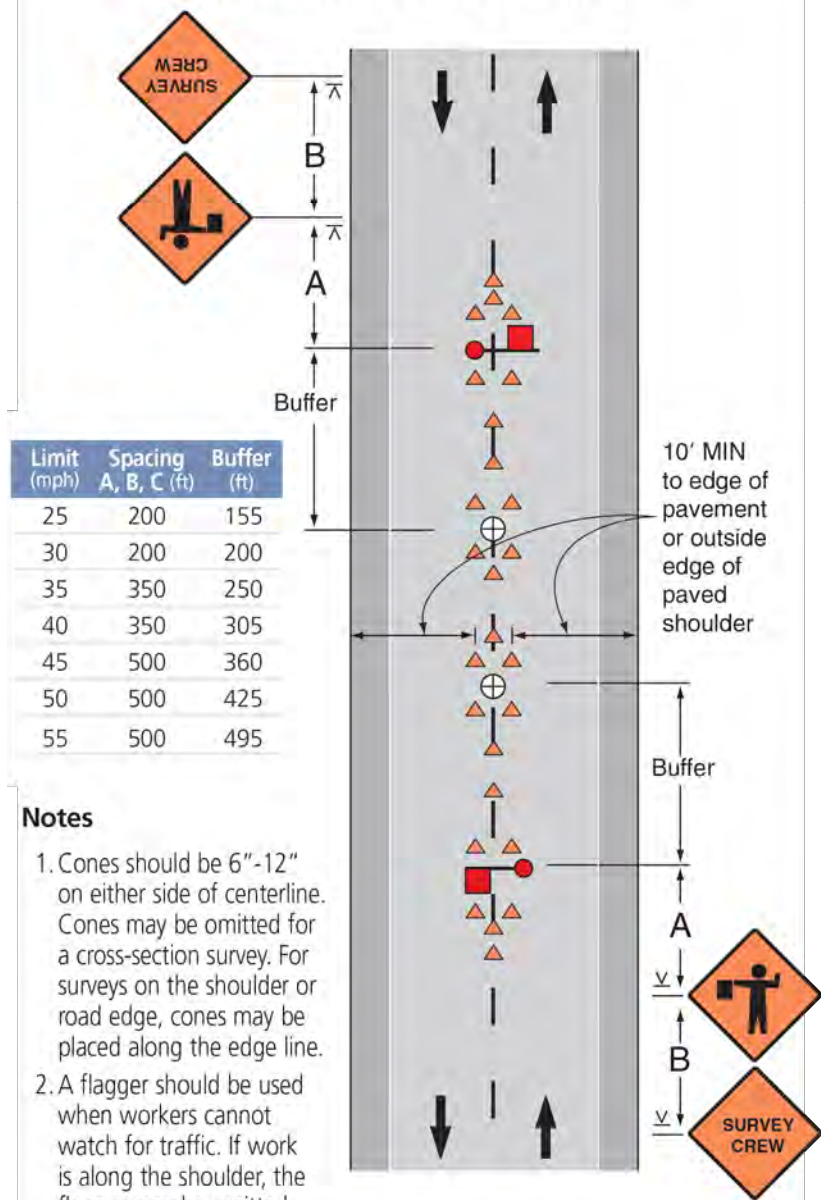

Limit (mph)	Spacing A, B, C (ft)	Buffer (ft)
25	200	155
30	200	200
35	350	250
40	350	305
45	500	360
50	500	425
55	500	495

- Notes**
1. Cones should be 6"-12" on either side of centerline. Cones may be omitted for a cross-section survey. For surveys on the shoulder or road edge, cones may be placed along the edge line.
 2. A flagger should be used when workers cannot watch for traffic. If work is along the shoulder, the flagger may be omitted.
 3. For surveying on the centerline of a road with high-volume, one lane shall be closed using layouts shown on page 26.
 4. A high-level warning device may be used to protect a surveying device, such as a target on a tripod.
 5. ROAD WORK AHEAD signs may be used in place of SURVEY CREW signs.

Temporary Road Closure (Daytime Only – 20 Minutes Maximum)

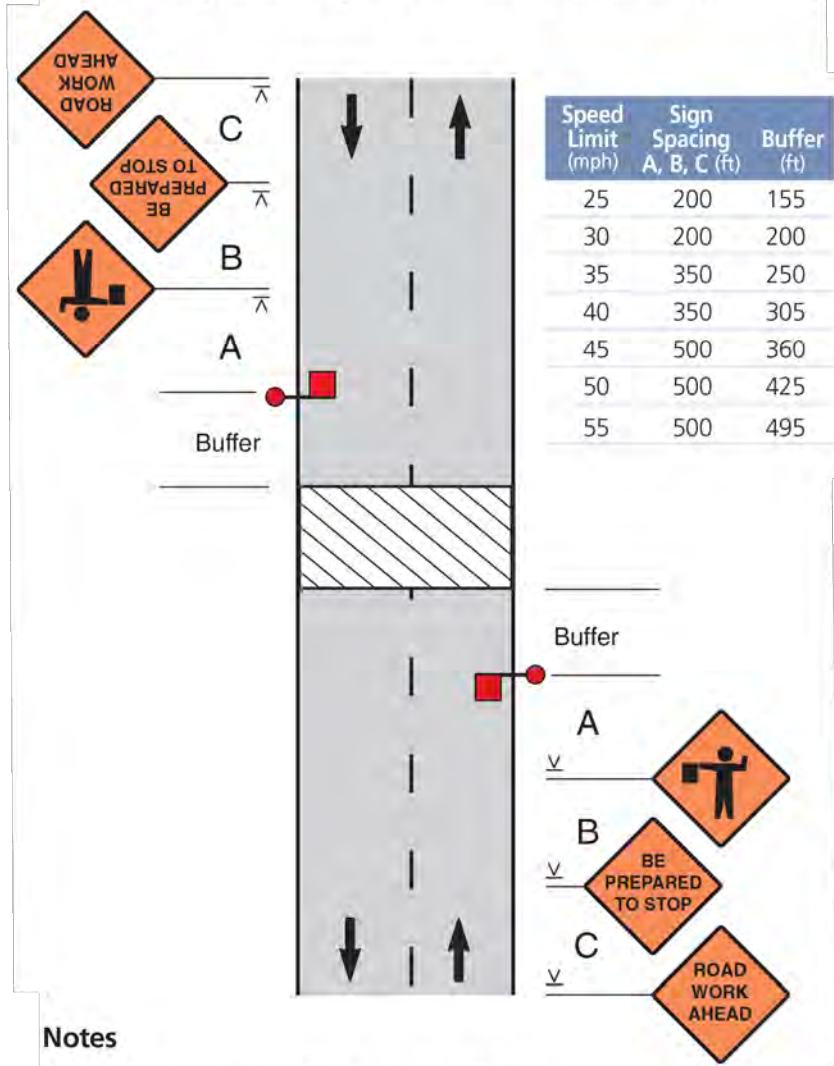

Speed Limit (mph)	Sign Spacing A, B, C (ft)	Buffer (ft)
25	200	155
30	200	200
35	350	250
40	350	305
45	500	360
50	500	425
55	500	495

- Notes**
1. Conditions represented are for work which requires closings during daytime hours only.
 2. This application is intended for a planned temporary closing not to exceed 20 minutes.
 3. Flaggers or uniformed officers shall be used for this application.
 4. The flagger should stop the first vehicle from the shoulder as shown. After stopping the first vehicle if the view of the flagger is obstructed, then he/she should move toward the centerline to stop additional traffic.
 5. Flaggers shall use approved flagging procedures according to the MUTCD and as shown on page 57.

Lane Shift on a Three-Lane, Two-Way Road

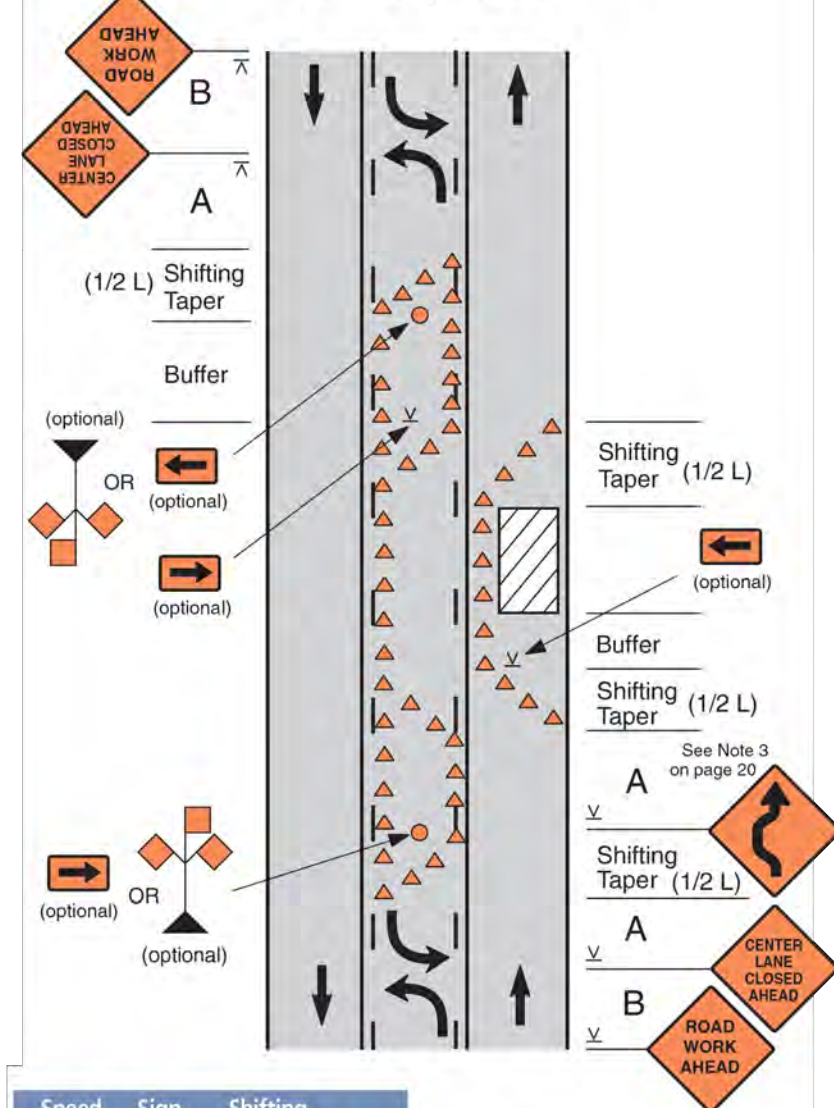

Speed Limit (mph)	Sign Spacing A, B (ft)	Shifting Taper (ft) for 12' lane	Buffer (ft)
25	200	65	155
30	200	90	200
35	350	125	250
40	350	160	305
45	500	270	360
50	500	300	425
55	500	330	495

- Notes**
1. Use turn restrictions or close driveways located in the work zone as appropriate.
 2. If speeds are 30 mph or less, Reverse Turn signs shall be used instead of Reverse Curve.

Lane Closure in Advance of an Intersection
(Work Area on the Through Road)

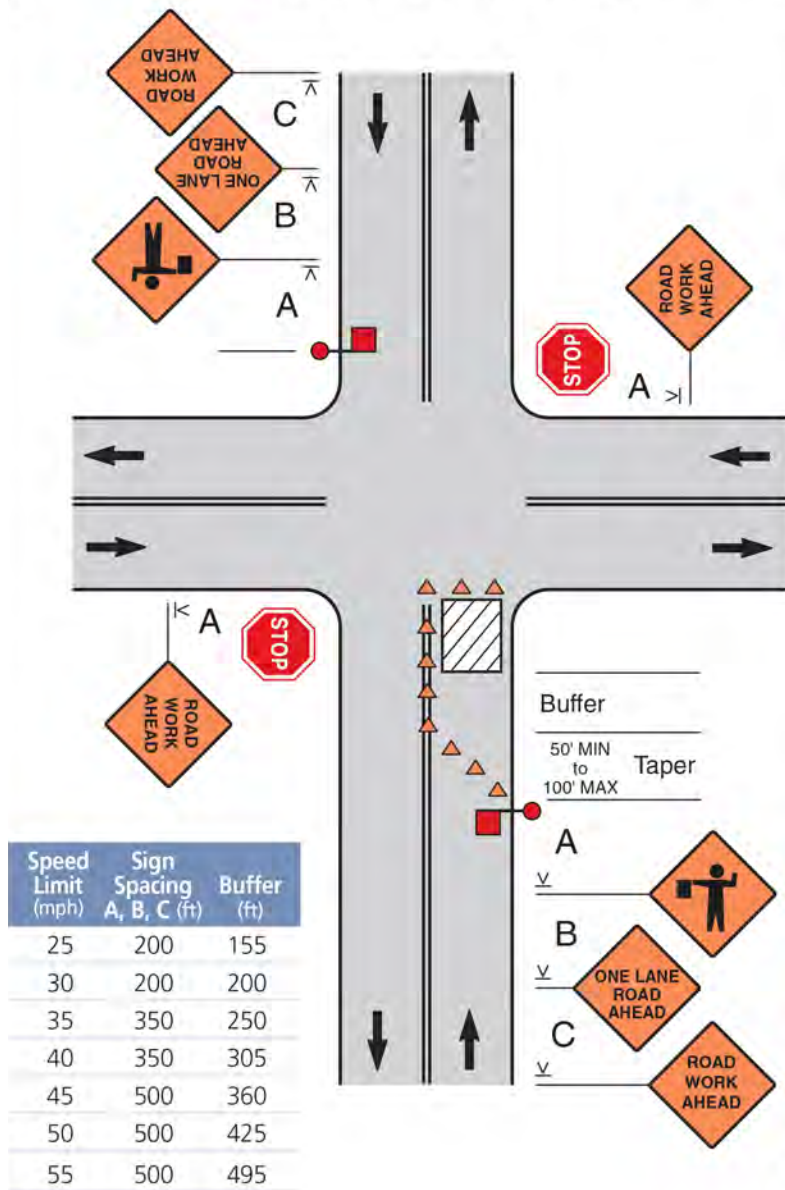

- Notes**
- Depending on traffic conditions, consider additional traffic control on the side road approaches, such as flaggers and appropriate signs.
 - The flaggers shall use approved flagging procedures according to the MUTCD and as shown on page 57.

Lane Closure in Advance of an Intersection
(Work Area on the Side Road)

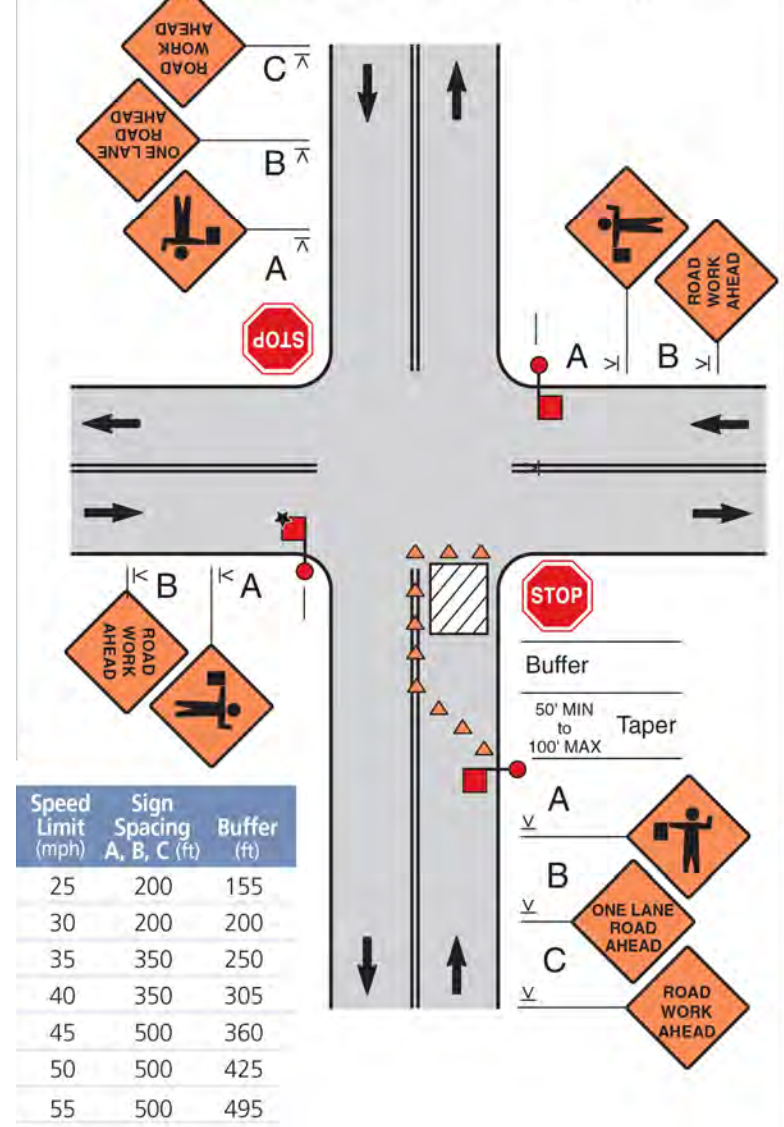

- Notes**
- Depending on traffic conditions, consider additional traffic control, such as flaggers and appropriate signs.
 - The middle flagger has the best view of traffic from all directions and would normally be **lead flagger** and coordinate the other flaggers.
 - The flaggers shall use approved flagging procedures according to the MUTCD and as shown on page 57.
 - A temporary STOP sign on the main street can also be used.

REV	DATE	DESCRIPTION	BY
A	07/22/24	ISSUED FOR REVIEW	HT
B	10/15/24	REVISED	BP
C	11/05/24	REVISED	BP

I HEREBY CERTIFY THAT THESE DRAWINGS WERE PREPARED BY ME OR UNDER MY DIRECT SUPERVISION AND CONTROL, AND TO THE BEST OF MY KNOWLEDGE AND BELIEF COMPLY WITH THE REQUIREMENTS OF ALL APPLICABLE CODES.

TASK NAME
WILC-FR03

TASK DESCRIPTION
FIBER OPTIC CONDUIT PLACEMENT

PROJECT AREA
LACROSSE, WI, USA

SHEET SCALE
N.T.S.

SHEET TITLE
TRAFFIC CONTROL STANDARD DETAILS

GRID NUMBER

SHEET NUMBER
TCP-7

Lane Closure Beyond an Intersection
(Work Area on the Through Road)

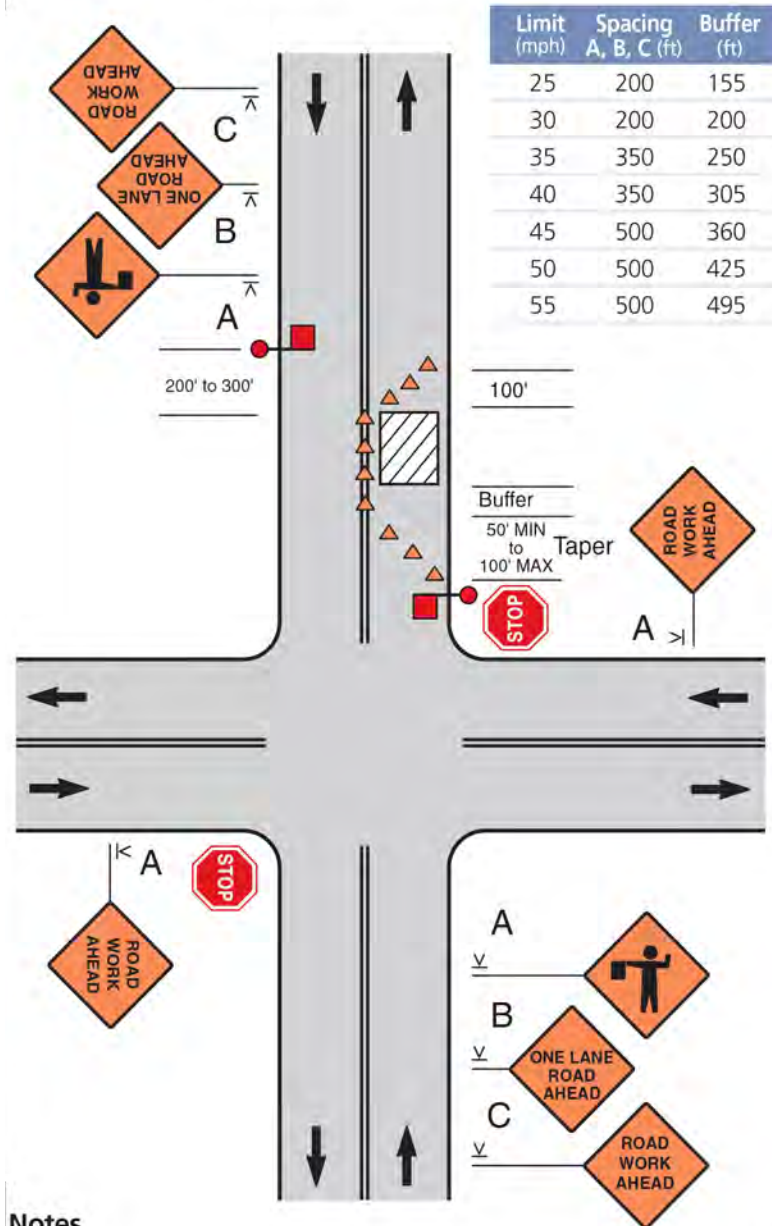

Notes

1. Depending on traffic conditions, consider additional traffic control, such as flaggers and appropriate signs.
2. The flaggers shall use approved flagging procedures according to the MUTCD and as shown on page 57.

Lane Closure Beyond an Intersection
(Work Area on the Side Road)

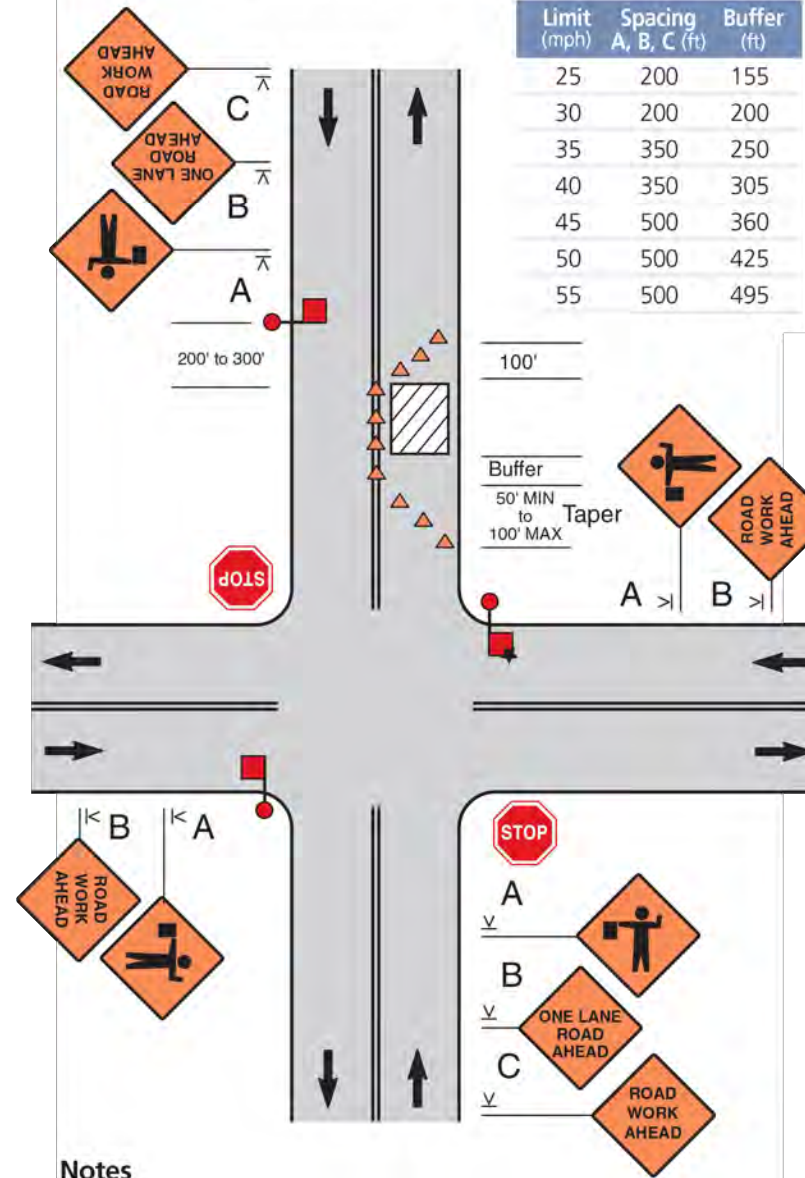

Notes

1. Depending on traffic conditions, consider additional traffic control, such as flaggers and appropriate signs.
- ★ 2. The middle flagger would normally be *lead flagger* and would coordinate the other flaggers.
3. The flaggers shall use approved flagging procedures according to the MUTCD and as shown on page 57.

REV	DATE	DESCRIPTION	BY
A	07/22/24	ISSUED FOR REVIEW	HT
B	10/15/24	REVISED	BP
C	11/05/24	REVISED	BP

I HEREBY CERTIFY THAT THESE DRAWINGS WERE PREPARED BY ME OR UNDER MY DIRECT SUPERVISION AND CONTROL, AND TO THE BEST OF MY KNOWLEDGE AND BELIEF COMPLY WITH THE REQUIREMENTS OF ALL APPLICABLE CODES.

TASK NAME
WILC-FR03

TASK DESCRIPTION
FIBER OPTIC CONDUIT PLACEMENT

PROJECT AREA
LACROSSE, WI, USA

SHEET SCALE
N.T.S.

SHEET TITLE
TRAFFIC CONTROL STANDARD DETAILS

GRID NUMBER

SHEET NUMBER
TCP-8

Mobile Operation on the Shoulder

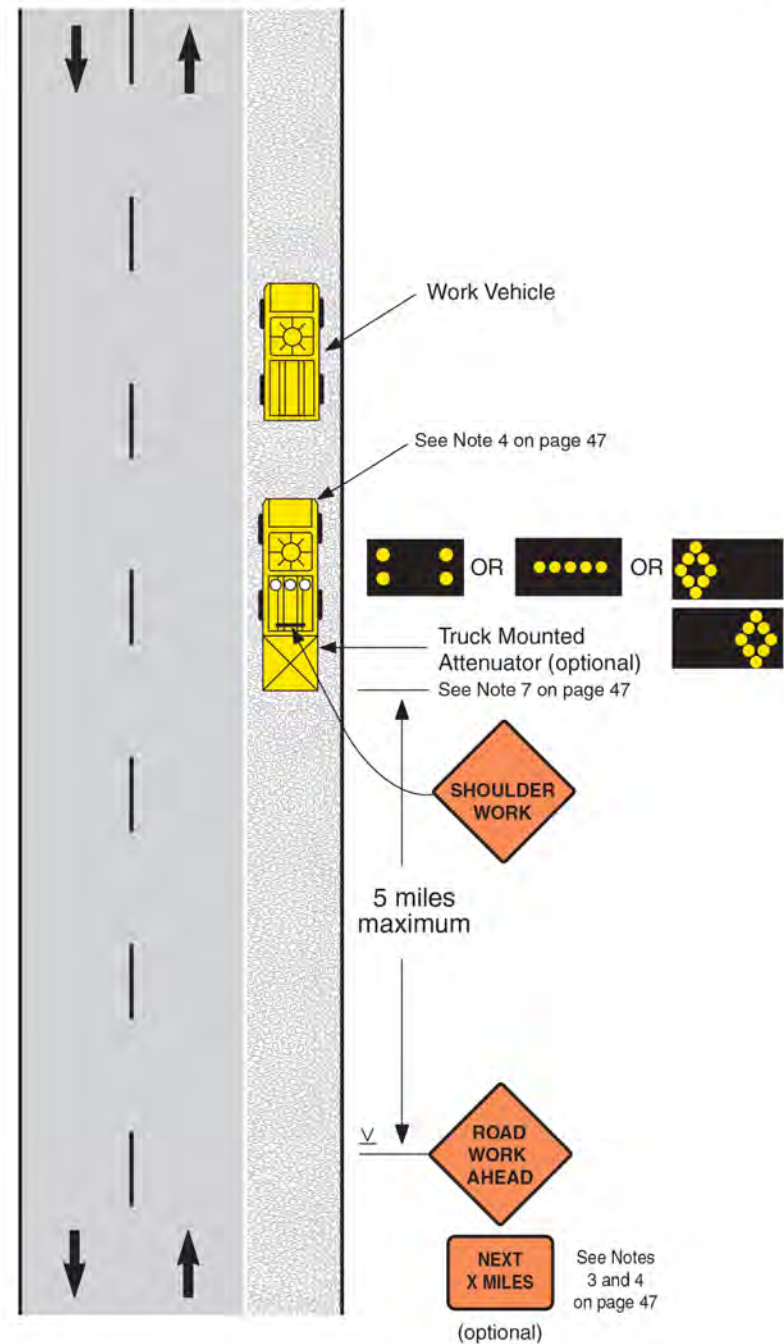

Mobile Operation on a Two-Lane Road

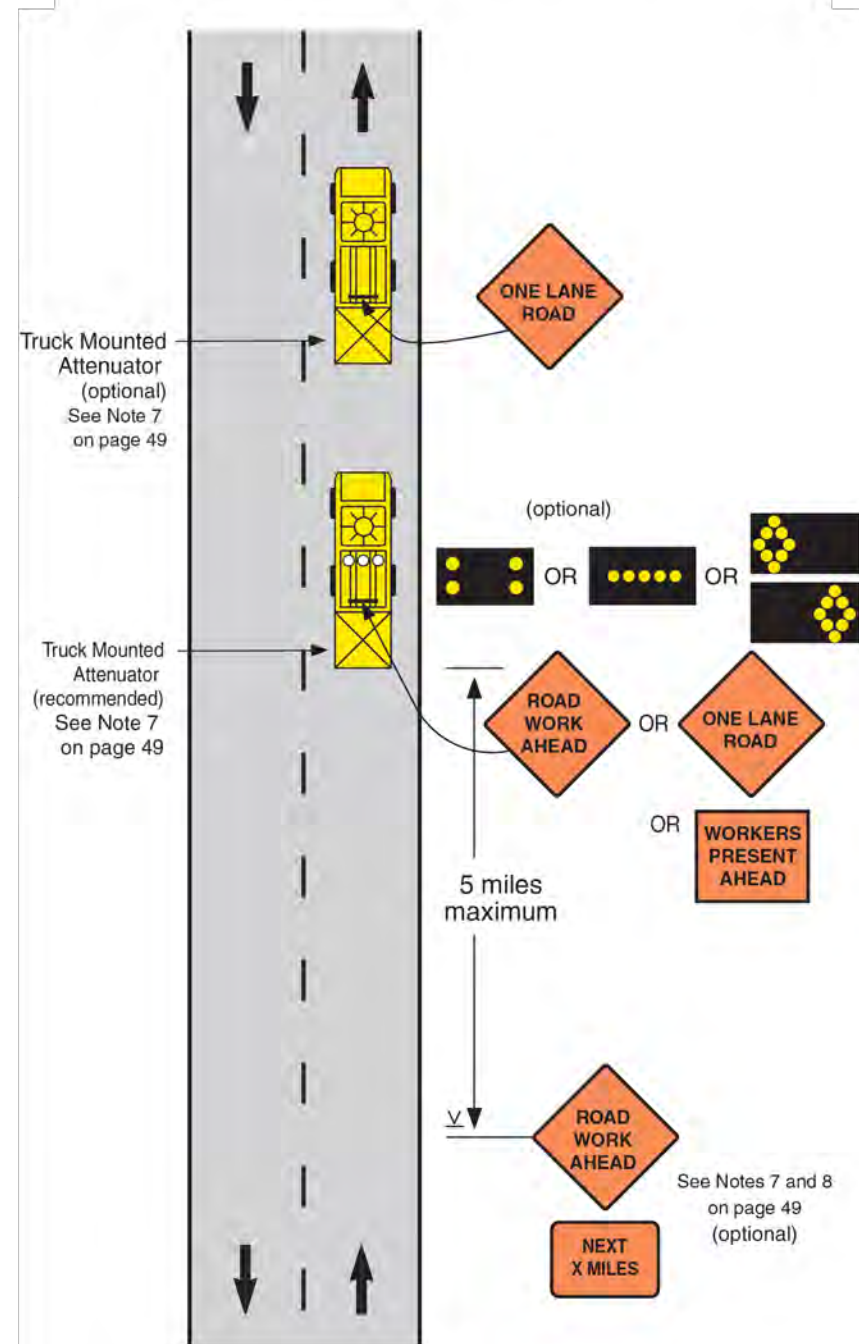

REV	DATE	DESCRIPTION	BY
A	07/22/24	ISSUED FOR REVIEW	HT
B	10/15/24	REVISED	BP
C	11/05/24	REVISED	BP

I HEREBY CERTIFY THAT THESE DRAWINGS WERE PREPARED BY ME OR UNDER MY DIRECT SUPERVISION AND CONTROL, AND TO THE BEST OF MY KNOWLEDGE AND BELIEF COMPLY WITH THE REQUIREMENTS OF ALL APPLICABLE CODES.

TASK NAME
WILC-FR03

TASK DESCRIPTION
FIBER OPTIC CONDUIT PLACEMENT

PROJECT AREA
LACROSSE, WI, USA

SHEET SCALE
N.T.S.

SHEET TITLE
TRAFFIC CONTROL STANDARD DETAILS

GRID NUMBER

SHEET NUMBER
TCP-9

Mobile Operation on a Two-Lane Road Using Flaggers (Traveling at less than 3 mph)

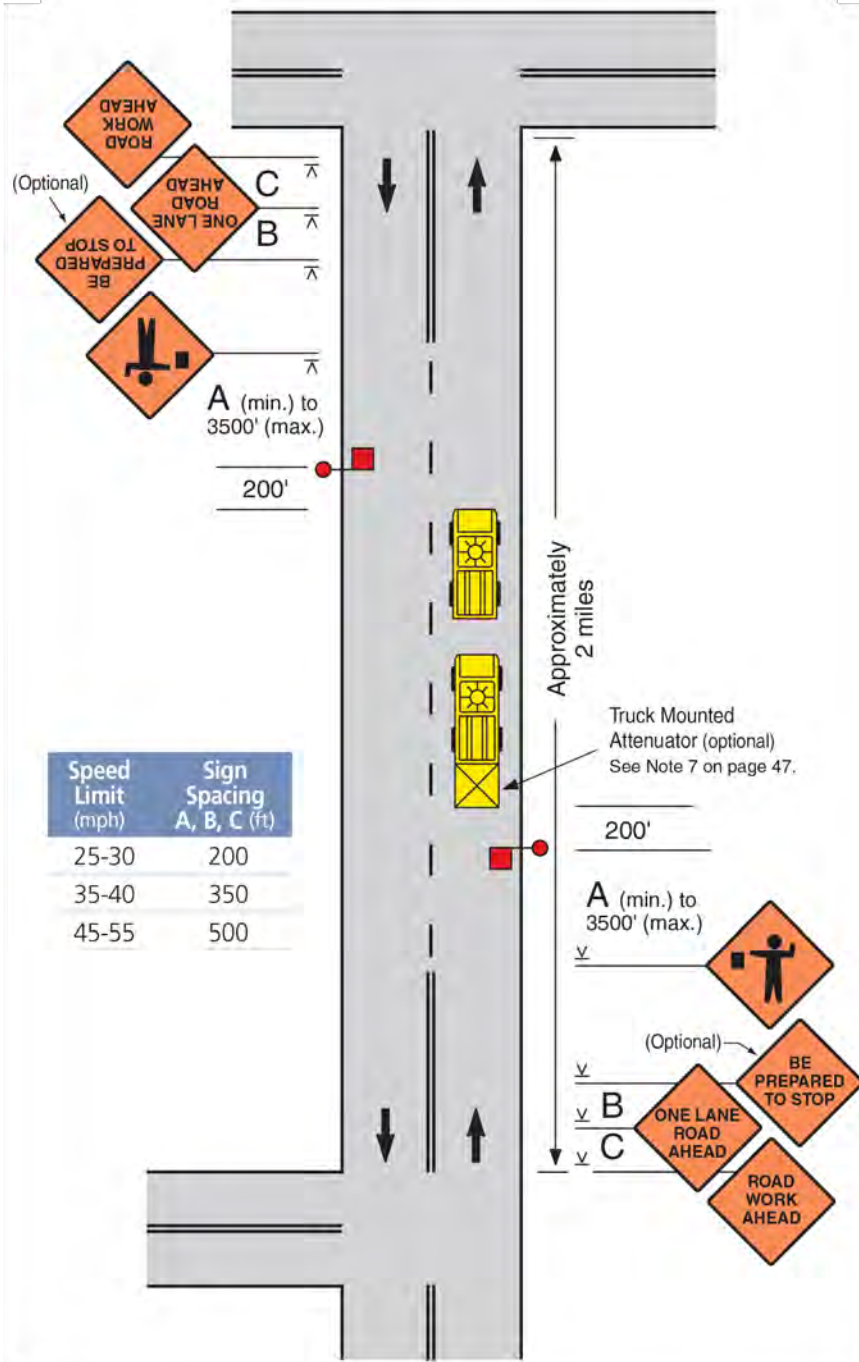

Mobile Operation on a Multi-Lane Road

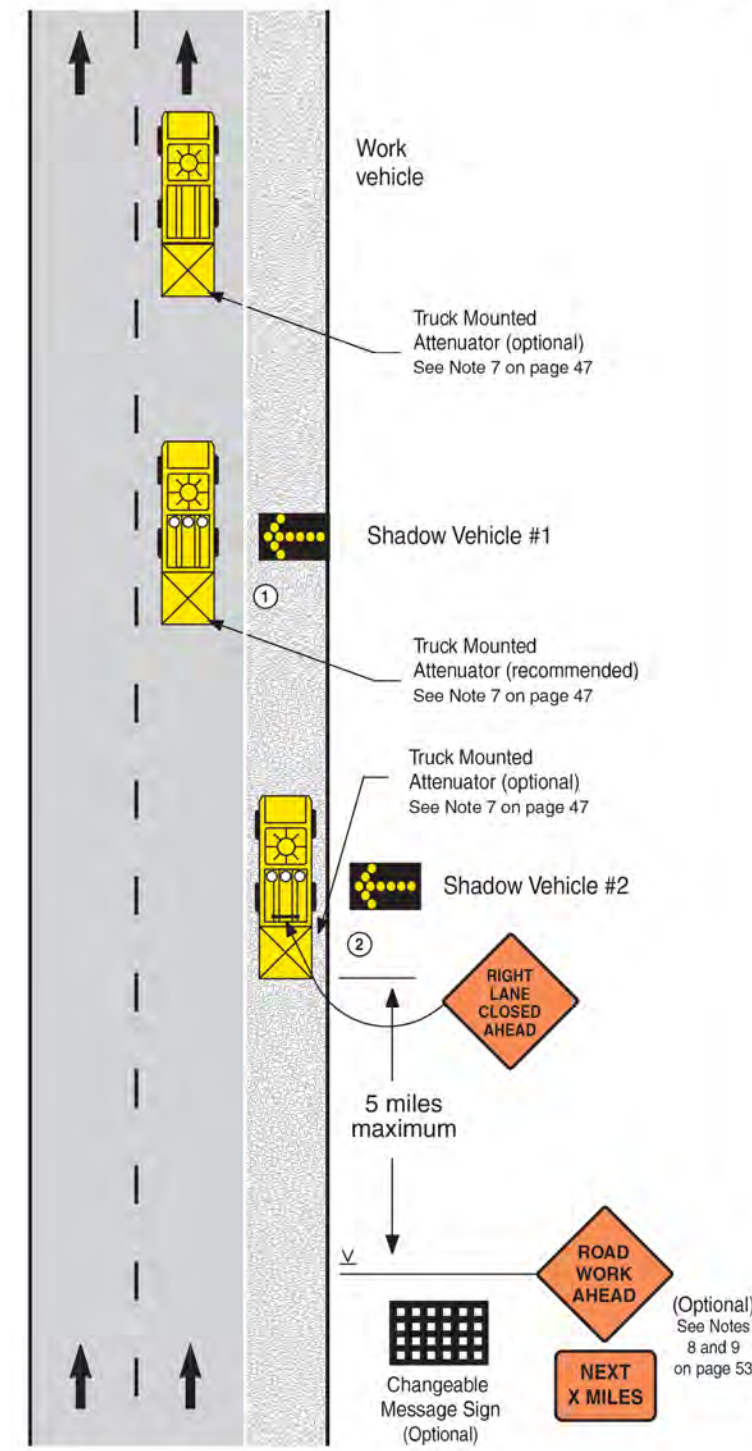

Flagging Procedures



Properly trained flaggers

- give clear messages to drivers as shown
- allow time and distance for drivers to react
- never stand in moving traffic lane
- coordinate with other flaggers

Properly equipped flaggers use

- approved sign paddles
- approved safety vest, shirt or coat
- brightly colored hat for better visibility
- retroreflective night equipment

Proper flagging stations have

- good approach sight distance
- high visibility to traffic
- illumination at night

Proper advance warning

- always use warning signs
- allow reaction distance from signs
- remove signs when not flagging

Flags should only be used in emergency situations. Flags used for signaling shall be a minimum of 24" x 24", red in color and mounted on a staff about 3' long.

See the *Flagger's Handbook* for more information on flagging procedures. Transportation Information Center-LTAP University of Wisconsin-Madison epd.wisc.edu/tic

REV	DATE	DESCRIPTION	BY
A	07/22/24	ISSUED FOR REVIEW	HT
B	10/15/24	REVISED	BP
C	11/05/24	REVISED	BP

I HEREBY CERTIFY THAT THESE DRAWINGS WERE PREPARED BY ME OR UNDER MY DIRECT SUPERVISION AND CONTROL, AND TO THE BEST OF MY KNOWLEDGE AND BELIEF COMPLY WITH THE REQUIREMENTS OF ALL APPLICABLE CODES.

TASK NAME	WILC-FR03
-----------	-----------

TASK DESCRIPTION	FIBER OPTIC CONDUIT PLACEMENT
------------------	-------------------------------

PROJECT AREA	LACROSSE, WI, USA
--------------	-------------------

SHEET SCALE	N.T.S.
-------------	--------

SHEET TITLE	TRAFFIC CONTROL STANDARD DETAILS
-------------	----------------------------------

GRID NUMBER	
-------------	--

SHEET NUMBER	TCP-10
--------------	--------