



TASK NAME: WILC013-U-S5

TASK DESCRIPTION: FIBE OPTIC CONDUIT PLACEMENT

SITE LOCATION: LACROSSE, WI, USA



3701 COMMUNICATIONS WAY
EVANSVILLE, IN, 47715



1100 E. WOODFIELD ROAD, SUITE 500
SCHAUMBURG, ILLINOIS 60173
TEL: 847-908-8400
DESIGN FIRM NO. 184.008202-0006
www.fullerton-us.com

PROJECT INFORMATION

TASK NAME: WILC013-U-S5
TASK DESCRIPTION: FIBE OPTIC CONDUIT PLACEMENT
SITE LOCATION: LACROSSE, WI, USA
SITE TYPE: UNDERGROUND FIBER-OPTIC CONSTRUCTION
JURISDICTION: LACROSSE, WI, USA
APN: -
ZONING CLASSIFICATION: -
OCCUPANCY TYPE: -
CONSTRUCTION TYPE: -
APPLICANT: METRO FIBERNET, LLC
ADDRESS: 3701 COMMUNICATIONS WAY
EVANSVILLE, IN, 47715
CONTACT: TARAN WELCHLIN
PHONE: (608) 606-2043
EMAIL: TARAN.WELCHLIN@METRONET.COM
NOTE: DRAWING SCALES ARE FOR 11"x17" SHEETS UNLESS OTHERWISE NOTED

PROJECT CONSULTANTS

PROJECT MANAGER: FULLERTON ENGINEERING CONSULTANTS, LLC
ADDRESS: 1100 E. WOODFIELD ROAD, SUITE 500
CONTACT: DAN MEIDEL
PHONE: (224) 612-0768
EMAIL: DMEIDEL@FULLERTONENGINEERING.COM
ENGINEER: FULLERTON ENGINEERING CONSULTANTS, LLC
ADDRESS: 1100 E. WOODFIELD ROAD, SUITE 500
SCHAUMBURG, ILLINOIS 60173
EOR: DAN SMITH, P.E.
PHONE: 847-908-8521
EMAIL: DSMITH@FULLERTONENGINEERING.COM
POWER COMPANY:
PHONE:
TELEPHONE COMPANY:
PHONE:

SCOPE OF WORK

THE SCOPE OF WORK CONSISTS OF:
INSTALLATION OF:

- 4,338' OF UNIQUE CONDUIT
- 7,658' OF 1.25" CONDUIT DIRECTIONAL BORE
- (4) B- HANDHOLE 17X30X18 (UTILITY BOX)
- (7) TB- HANDHOLE 13X24X15 (TERMINAL BOX)
- (31) DB- HANDHOLE 11X11X10 (DROP BOX)

• ALL MATERIAL SHALL BE INSTALLED BY THE CONTRACTOR, UNLESS STATED OTHERWISE.

SITE LOCATION MAP

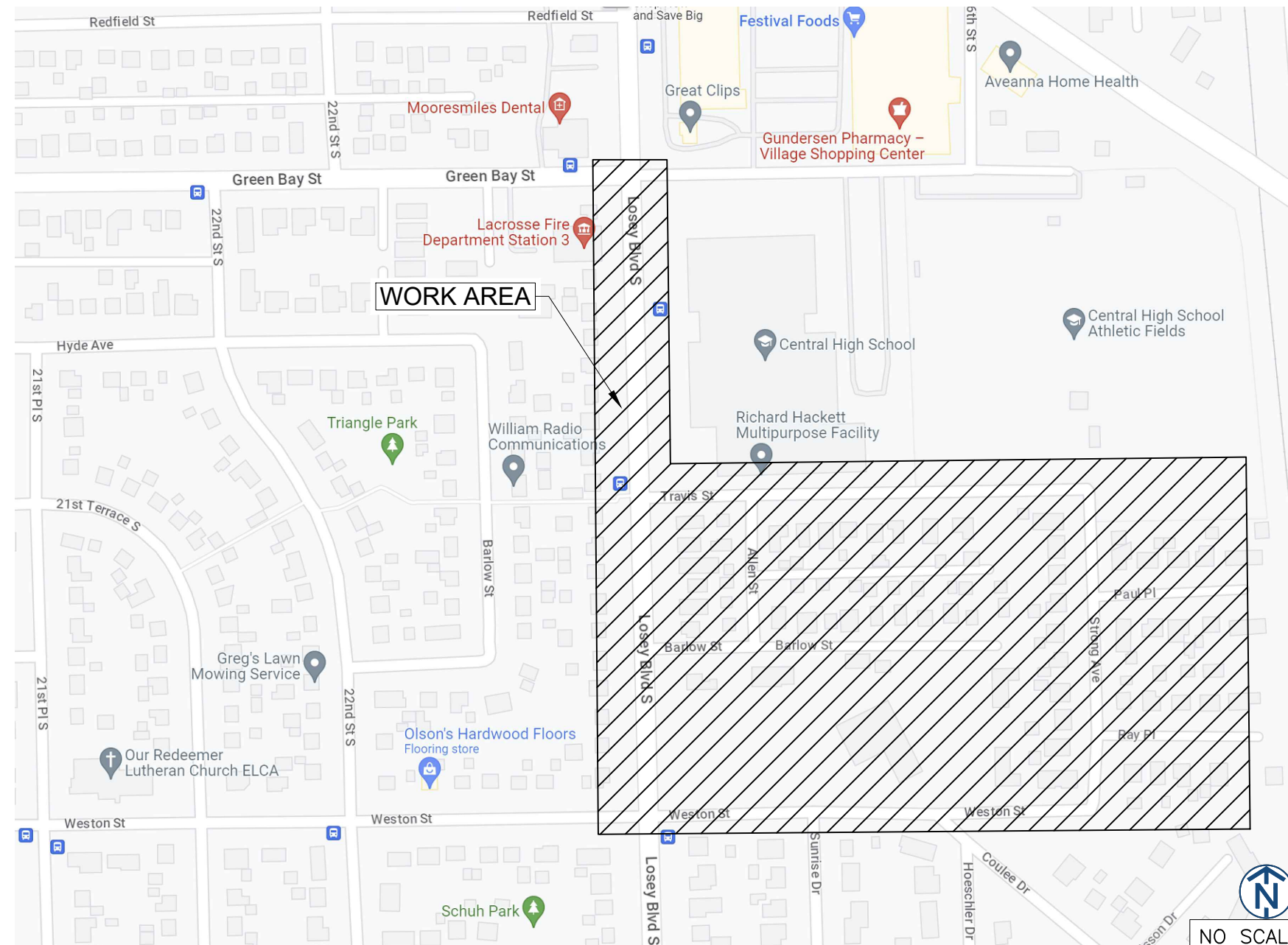

REV	DATE	DESCRIPTION	BY
A	08/23/23	ISSUED FOR REVIEW	NS
B	08/29/23	REVISED	NS

I HEREBY CERTIFY THAT THESE DRAWINGS WERE PREPARED BY ME OR UNDER MY DIRECT SUPERVISION AND CONTROL, AND TO THE BEST OF MY KNOWLEDGE AND BELIEF COMPLY WITH THE REQUIREMENTS OF ALL APPLICABLE CODES.

TASK NAME

WILC013-U-S5

TASK DESCRIPTION
FIBE OPTIC CONDUIT PLACEMENT

PROJECT AREA
LACROSSE, WI, USA

SHEET SCALE
N.T.S.

SHEET TITLE
TITLE SHEET

GRID NUMBER

SHEET NUMBER
T-1



NO SCALE

SHEET NUMBER	SHEET TITLE
T-1	TITLE SHEET
T-2	SHEET INDEX
T-3	LEGEND
GN-1	GENERAL NOTES
MAP-1	MAP
C-01	DESIGN LAYOUT
C-02	DESIGN LAYOUT
C-03	DESIGN LAYOUT
C-04	DESIGN LAYOUT
C-05	DESIGN LAYOUT
C-06	DESIGN LAYOUT
C-07	DESIGN LAYOUT
C-08	DESIGN LAYOUT
C-09	DESIGN LAYOUT
C-10	DESIGN LAYOUT
D-1	DETAILS
D-2	DETAILS
D-3	DETAILS
D-4	DETAILS
TCP-1	TRAFFIC CONTROL STANDARD

SHEET NUMBER	SHEET TITLE

SHEET NUMBER	SHEET TITLE



REV	DATE	DESCRIPTION	BY
A	08/23/23	ISSUED FOR REVIEW	NS
B	08/29/23	REVISED	NS

I HEREBY CERTIFY THAT THESE DRAWINGS WERE PREPARED BY ME OR UNDER MY DIRECT SUPERVISION AND CONTROL, AND TO THE BEST OF MY KNOWLEDGE AND BELIEF COMPLY WITH THE REQUIREMENTS OF ALL APPLICABLE CODES.

REV. NO	REVISION	DATE:

TASK NAME
WILC013-U-S5

TASK DESCRIPTION
FIBE OPTIC CONDUIT PLACEMENT

PROJECT AREA
LACROSSE, WI, USA

SHEET SCALE
N.T.S.









SHEET TITLE
SHEET INDEX

GRID NUMBER







SHEET NUMBER
T-2

LEGEND

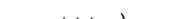









PROPOSED

-  PROPOSED OPEN CUT TRENCH
-  PROPOSED DIRECTIONAL BORE
-  PROPOSED BORE PIT
-  PROPOSED L-HANDHOLE(30X48X24)
-  PROPOSED M-HANDHOLE(24X36X18)
-  PROPOSED B-UTILITY BOXES(17X30X18)
-  PROPOSED TERMINAL BOXES(13X24X15)
-  PROPOSED DROP BOXES(11X11X12)







SEWER

-  EXISTING SEWER MAIN
-  EXISTING SEWER MAIN (ABANDON)
-  EXISTING STORM SEWER MAIN
-  EXISTING STORM MANHOLE
-  EXISTING SEWER MANHOLE
-  EXISTING SEWER CATCH BASIN
-  EXISTING SEWER INLET

WATER

-  EXISTING WATER MAIN
-  EXISTING WATER MAIN (ABANDON)
-  EXISTING WATER SHUT OFF
-  EXISTING FIRE CISTERN MANHOLE
-  EXISTING WATER CAP
-  EXISTING WATER MANHOLE
-  EXISTING WATER VALVE
-  EXISTING WATER METER
-  EXISTING FIRE HYDRANT
-  EXISTING WATER REDUCER











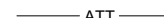
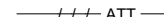

GAS

-  EXISTING GAS MAIN
-  EXISTING GAS MAIN (DEAD)
-  EXISTING GAS CAP
-  EXISTING GAS REDUCER
-  EXISTING GAS MANHOLE
-  EXISTING GAS VALVE
-  EXISTING GAS METER























DEO/ELECTRIC

-  EXISTING DEO/ELECTRIC
-  EXISTING STREET LIGHT CONTROL BOX
-  EXISTING TRAFFIC LIGHT CONTROL BOX
-  EXISTING STREET LIGHT HANDHOLE
-  EXISTING TRAFFIC LIGHT HANDHOLE
-  EXISTING RED LIGHT CAMERA POLE
-  EXISTING STREET LIGHT POLE
-  EXISTING TRAFFIC LIGHT POLE
-  EXISTING DEO POLE
-  EXISTING ELECTRIC MANHOLE
-  EXISTING ELECTRIC HANDHOLE
-  EXISTING RED LIGHT FLASH POLE

COMMUNICATIONS

-  EXISTING AT&T
-  EXISTING AT&T (ABANDON)
-  EXISTING COMMUNICATIONS
-  EXISTING MCI
-  EXISTING SPRINT
-  EXISTING SUNESYS
-  EXISTING VERIZON
-  EXISTING CITY FIBER
-  EXISTING AT&T MANHOLE
-  EXISTING COMMUNICATIONS MANHOLE
-  EXISTING MCI
-  EXISTING SPRINT/NEXTEL MANHOLE
-  EXISTING SUNESYS MANHOLE
-  EXISTING VERIZON MANHOLE

MISCELLANEOUS

-  EXISTING FENCE
-  EXISTING CONSTRUCTION FENCE
-  EXISTING GUARDRAIL
-  EXISTING PROPERTY LINE/ R.O.W.
-  EXISTING BIKE RACK
-  EXISTING TREE
-  EXISTING BUSH
-  EXISTING STREET SIGN POST
-  EXISTING POST/BOLLARD
-  EXISTING GROUND LIGHT
-  EXISTING UTILITY POLE
-  EXISTING STANDPIPE
-  EXISTING ADA RAMP
-  EXISTING MISCELLANEOUS MANHOLE
-  EXISTING GARBAGE CAN
-  EXISTING PARK DISTRICT MANHOLE
-  EXISTING MONITORING WELL
-  EXISTING FIRE ALARM
-  EXISTING STREET PARKING PAY BOX
-  EXISTING PEDESTAL
-  EXISTING MAILBOX
-  EXISTING NEWSPAPER BOX
-  EXISTING PHONE
-  EXISTING SPRINKLER CONTROL BOX
-  EXISTING SPRINKLER VALVE
-  EXISTING SUPPORT COLUMN

REV	DATE	DESCRIPTION	BY
A	08/23/23	ISSUED FOR REVIEW	NS
B	08/29/23	REVISED	NS

I HEREBY CERTIFY THAT THESE DRAWINGS WERE PREPARED BY ME OR UNDER MY DIRECT SUPERVISION AND CONTROL, AND TO THE BEST OF MY KNOWLEDGE AND BELIEF COMPLY WITH THE REQUIREMENTS OF ALL APPLICABLE CODES.

TASK NAME
WILC013-U-S5

TASK DESCRIPTION
FIBE OPTIC CONDUIT PLACEMENT

PROJECT AREA
LACROSSE, WI, USA

SHEET SCALE
N.T.S.

SHEET TITLE
LEGEND

GRID NUMBER

SHEET NUMBER
T-3

1. THE ENCLOSED DESIGN MAY IMPLY EXISTING UTILITIES. THE UTILITIES HAVE NOT BEEN FIELD VERIFIED FOR LOCATION. THEREFORE, ALL UTILITIES IMPLIED WITHIN THIS DOCUMENT ARE TO BE REFERRED TO AS A "REFERENCE TOOL". IT IS THE RESPONSIBILITY OF THE GENERAL CONTRACTOR AND/OR IT'S SUBCONTRACTOR TO VERIFY THESE UTILITIES USING ANY AND ALL METHODS AND INSTRUMENTS AVAILABLE IF/WHEN NECESSARY. FULLERTON CANNOT IN GOOD FAITH GUARANTEE UTILITY LOCATIONS. ANY AND ALL DOCUMENTATION ON EXISTING UTILITIES HAS BEEN IMPLIED UTILIZING INFORMATION RETRIEVAL PROCESSES FROM EACH JURISDICTION INVOLVED (STATE, COUNTY AND/OR MUNICIPALITY, TO INCLUDE OTHERS).
2. IT IS THE RESPONSIBILITY OF THE GENERAL CONTRACTOR TO ENSURE ALL CONDUITS ARE PLACED WITHIN THE GIVEN & DEDICATED SPACE LICENSED FOR THIS PARTICULAR CLIENT. FULLERTON ENGINEERING CONSULTANTS, INC. (FULLERTON) WAS NOT RETAINED FOR THE PURPOSE OF SUPPORTING A SURVEY OF THE AREA AND PROPERTY BOUNDARIES, THEREFORE FULLERTON CAN NOT AND WILL NOT SUPPORT THE ACCURACY OF ANY IMPLIED BOUNDARY (I.E. PUBLIC WAY, PRIVATE PROPERTY, EASEMENT ETC.) NOR IS IT TO BE ASSUMED THAT THE SALE OF PROPERTIES HAS NOT OCCURRED DURING & AFTER FULLERTON'S RESPONSIBILITIES FOR THIS PROJECT HAVE PAST. ALL BOUNDARIES, EASEMENTS, PROPERTY LINES, ETC. ARE TO BE USED AS A GUIDELINE OR REFERENCE AND SHOULD NOT BE TAKEN LITERALLY. IT IS THE CONTRACTOR'S RESPONSIBILITY TO HAVE ASSOCIATED BOUNDARIES SURVEY STAKED IF SO QUESTIONED. ALL ASPECTS OF BOUNDARIES IMPLIED HEREIN, HAVE BEEN DERIVED THROUGH AVAILABLE MEDIA SUCH AS BUT NOT LIMITED TO (SIDWELL, GOOGLE EARTH PRO. MUNICIPAL, STATE, COUNTY, GIS, AND OTHER RECORD TYPES). FULLERTON DOES NOT AGREE NOR DISAGREE WITH THE ABOVE-MENTIONED RECORDS AS THEY ARE USED JUST A REFERENCE TOOL.
3. ALL BURIED OBSTRUCTIONS KNOWN BY FULLERTON ARE SHOWN ON THE CONSTRUCTION DRAWINGS. ANY AND ALL OTHERS ENCOUNTERED DURING CONSTRUCTION ARE THE RESPONSIBILITY OF THE CONTRACTOR TO LOCATE AND PROTECT.
4. CONTRACTOR IS RESPONSIBLE FOR LOCATING ALL UTILITIES 48 HOURS PRIOR TO CONSTRUCTION ACTIVITY.
5. SHORING MAY BE REQUIRED AND SHALL COMPLY TO O.S.H.A. STANDARDS.
6. ALL BURIED CONDUIT/CABLE WILL BE PLACED AT 30-48" MINIMUM COVER UNLESS SPECIFIED OR OTHERWISE NOTED ON THE CONSTRUCTION DRAWINGS.
7. ANY AND ALL IMPROVEMENTS, IF DAMAGED, SHALL BE RESTORED TO ORIGINAL OR BETTER CONDITION. THIS INCLUDES BUT IS NOT LIMITED TO: ASPHALT, CONCRETE PAVEMENT, CURBS, GUTTERS, SIDEWALKS, DRAINAGE DITCHES, EMBANKMENTS, SHRUBS, TREES, GRASS SOD, ETC..
8. ALL FIBER INSTALLATIONS SHALL OBSERVE A MINIMUM DYNAMIC BEND RADIUS OF 20X THE CABLE DIAMETER FOR ALL OSP FIBER SHEATHS AND 15X THE CABLE DIAMETER FOR ALL ISP FIBER SHEATHS. ADDITIONALLY, ALL INSTALLATIONS SHALL OBSERVE A MINIMUM STATIC BEND RADIUS OF 15X THE CABLE DIAMETER FOR ALL OSP FIBER SHEATHS AND 10X THE CABLE DIAMETER FOR ALL ISP FIBER SHEATHS. IF THE MANUFACTURER'S SPECIFICATIONS FOR BEND RADIUS ARE GREATER, THEN THEY SHALL BE FOLLOWED.
9. ALL NEW METALLIC AERIAL STRAND SHALL BE BONDED/GROUNDED (PREFERABLY TO THE POWER COMPANY NEUTRAL) PER LOCAL REQUIREMENTS. AT A MINIMUM, THE BONDING/GROUNDING PATTERN SHALL BE THE FIRST AND LAST POLE OF A RUN AND EVERY TENTH POLE IN THE RUN. SHOULD ONE OF THESE DESIGNATED POLES SUPPORT A POWER TRANSFORMER, THE POLES ON EITHER SIDE OF SAID POLE SHALL BE BONDED/GROUNDED AND THE PATTERN SHOULD CONTINUE EVERY TENTH POLE FROM THAT STARTING POINT.
10. ALL AERIAL FIBER OPTIC CABLES SHALL BE SECURELY LASHED TO AERIAL STRAND BY METHOD OF MECHANICAL LASHING CARRIAGE OR APPROVED EQUAL.
11. ALL FIBER OPTIC CABLES INSTALLED BELOW GRADE SHALL BE OF AN ARMORED VARIETY WITH METALLIC INNER SHEATH, OR BE PLACED WITH A METALLIC LOCATING WIRE TO FACILITATE FUTURE LOCATING SERVICES.
12. ALL CONDUIT OR DUCT CONSTRUCTION SHALL INCLUDE THE PLACEMENT OF PULLING TAPE OF SUFFICIENT SIZE AND GRADE TO FACILITATE THE INSTALLATION OF THE SPECIFIED FIBER TYPE THROUGH CONDUIT BEING UTILIZED (JETLINE USE TO BE APPROVED BY CLIENT).
13. ALL FUSION SPLICING SHALL BE COMPLETED BY A QUALIFIED FIBER SPLICER IN A CLEAN TEMPERATURE CONTROLLED TRUCK, TRAILER, OR SHELTER SPECIFICALLY TOOLED OR DESIGNED FOR THE PURPOSE OF FUSION SPLICING FIBER OPTIC CABLES IN A FIELD ENVIRONMENT.
14. ALL MECHANICAL SPLICES AND FACTORY ENDS SHALL BE KEPT CLEAN AND FREE FROM DUST, DIRT, OILS, AND SMEARS. CARE SHOULD BE TAKEN TO MATCH POLISH TYPES ON FACTORY ENDS.
15. CONTRACTOR SHALL BE RESPONSIBLE FOR ANY AND ALL CORRECTIONS TO WORK IDENTIFIED AS UNACCEPTABLE BY CLIENT, ENGINEER, OR INSPECTOR, DURING SITE INSPECTION ACTIVITIES AND/OR AS A RESULT OF TESTING. CONTRACTOR SHALL ALSO PROVIDE ALL AS-BUILT INFORMATION UPON COMPLETION OF INSPECTION.
16. CONTRACTOR SHALL KEEP THE SITE FREE FROM ACCUMULATING WASTE MATERIAL, DEBRIS, AND TRASH. AT THE COMPLETION OF THE WORK, CONTRACTOR SHALL REMOVE FROM THE SITE ALL REMAINING RUBBISH, IMPLEMENTS, TEMPORARY FACILITIES, AND SURPLUS MATERIALS. CONTRACTOR TO RETURN SITE TO PREVIOUS OR BETTER CONDITION.
17. DRAWINGS ARE INTENDED TO SHOW DESIGN INTENT. CONTRACTOR SHALL PROVIDE MATERIALS AND LABOR AS REQUIRED TO PRODUCE A COMPLETE AND FUNCTIONING SYSTEM WHILE MEETING ALL CODES AND SPECIFICATIONS. MODIFICATIONS MAY BE REQUIRED TO SUIT JOB DIMENSIONS OR CONDITIONS. SUCH MODIFICATIONS SHALL BE INCLUDED IN THE WORK. SAID DESIGN IS INTENDED TO AVOID DISRUPTION OF ANY HANDICAP RAMPS OR STRUCTURES AS DESCRIBED PER THE AMERICANS WITH DISABILITIES ACT OF 1990.
18. CONTRACTOR SHALL WORK WITH CLIENT TO IDENTIFY ALL CONTRACTOR SUPPLIED MATERIALS TO CONSTRUCT NETWORK PER

SPECIFICATIONS.

19. THE CONTRACTOR SHALL PROVIDE ALL MATERIAL, EQUIPMENT, LABOR, INSTALLATION, RESTORATION, UTILITY RELOCATION CHARGES, JOB SITE DELIVERY COSTS AND INCIDENTALS TO COMPLETE THE DESCRIBED OR ILLUSTRATED WORK UNDER THIS CONTRACT.
20. ANY CHANGE-ORDER REQUEST MUST BE PRESENTED IN WRITING TO THE OWNER'S REPRESENTATIVE AND APPROVED PRIOR TO PROCEEDING WITH THE REQUESTED CHANGE.
21. THE ENGINEER WILL NOT BE RESPONSIBLE NOR ASSUME ANY LIABILITY FOR NEGLIGENT ACTS OR ERRORS OF OMISSIONS OF ANY CONTRACTOR, ANY SUBCONTRACTOR, OR ANY OF THE PERSONS (EXCEPT ENGINEER'S OWN EMPLOYEES) AT THE PROJECT SITE OR OTHERWISE PERFORMING ANY OF THE WORK OF THE PROJECT. ANY CONTRACTOR OR SUBCONTRACTOR, AS WELL AS THE ENGINEER, WILL BE RESPONSIBLE FOR HIS OWN SAFETY PROGRAM. NEITHER THE PROFESSIONAL ACTIVITIES OF THE ENGINEER, NOR THE PRESENCE OF THE ENGINEER OR HIS OR HER EMPLOYEES AND SUB-CONSULTANTS AT THE CONSTRUCTION SITE, SHALL RELIEVE ANY CONTRACTOR OF HIS OR HER OBLIGATIONS, DUTIES AND RESPONSIBILITIES INCLUDING, BUT NOT LIMITED TO, CONSTRUCTION MEANS, METHODS, SEQUENCE, TECHNIQUES OR PROCEDURES NECESSARY FOR PERFORMING, SUPERINTENDING OR COORDINATING ALL PORTIONS OF THE WORK OF CONSTRUCTION IN ACCORDANCE WITH THE CONTRACT DOCUMENTS AND ANY HEALTH OR SAFETY PRECAUTIONS REQUIRED BY ANY REGULATORY AGENCIES. THE ENGINEER AND HIS OR HER PERSONNEL HAVE NO AUTHORITY TO EXERCISE ANY CONTROL OVER ANY CONSTRUCTION CONTRACTOR OR OTHER ENTITY OR THEIR EMPLOYEES IN CONNECTION WITH ANY HEALTH OR SAFETY PRECAUTIONS.
22. ALL MATERIALS INSTALLED WITHIN THE LIMITS OF THIS PROJECT SHALL BE IN CONFORMANCE WITH STANDARD RECOMMENDATIONS OF THE NATIONAL ELECTRIC MANUFACTURER'S ASSOCIATION (NEMA) AND THE AMERICAN NATIONAL STANDARDS INSTITUTE (ANSI).
23. THE CONTRACTOR SHALL OBTAIN ALL PERMITS AND COMPLY WITH THE REQUIREMENTS OF ALL AGENCIES HAVING JURISDICTION OVER THE WORK AND SHALL COORDINATE HIS WORK WITH THE WORK PERFORMED BY OTHERS FOR THE PURPOSE OF INSTALLATION. THIS INCLUDES, BUT IS NOT LIMITED TO, ALL WORK WITH ALL PUBLIC AND PRIVATE UTILITIES AS WELL AS CITY AND STATE AGENCIES.
24. CONTRACTOR SHALL RECORD THE LOCATION AND ELEVATION OF ALL UTILITIES ENCOUNTERED, AND INSTALLATION OF NEW WORK, AS THE WORK PROGRESSES AND SHALL PREPARE RECORD DRAWINGS (RED-LINES) BASED ON HIS RECORDS. AS A PART OF THE RECORD DRAWINGS, CONTRACTOR SHALL ALSO PROVIDE HORIZONTAL AND VERTICAL CONFIGURATION OF CONDUITS WHERE MULTIPLE CONDUITS ARE INSTALLED. THESE RECORDS ARE TO BE SUPPLIED TO FULLERTON ENGINEERING AT COMPLETION OF WORK.
25. MAINTAIN MORE THAN 2'-0" VERTICAL CLEARANCE AND MORE THAN 4'-0" HORIZONTAL CLEARANCE BETWEEN EXISTING SEWER OR SEWER STRUCTURES AND UTILITY. IF CITY SEWER FACILITIES ARE DAMAGED DURING CONSTRUCTION, IT MUST BE REPORTED TO CITY ENGINEERING SECTION AND MUST BE REPAIRED BY A LICENSED DRAIN LAYER UNDER THE SUPERVISION OF THE MASON INSPECTOR.
26. NO STORAGE OF EQUIPMENT OR MATERIALS IN THE ROADWAY IS PERMITTED UNLESS THE CONTRACTOR OBTAINS WRITTEN PERMISSION FROM THE CITY, STATE, AND/OR GOVERNING BODY.
27. CONTRACTOR RESPONSIBLE FOR OBTAINING AND PROVIDING REVIEW AND DESIGN OF ANY AND ALL SHORING SYSTEMS PRIOR TO CONSTRUCTION.
28. THE ENGINEER SHALL BE NOTIFIED FOR DISPOSITION OF SITUATIONS WHERE THE CONDUIT CANNOT MAINTAIN SEPARATIONS PER PLAN.
29. THE CONTRACTOR IS RESPONSIBLE FOR THE RESTORATION OF THE AREAS DISTURBED BY CONSTRUCTION ACTIVITIES. CONTRACTOR IS TO PAY ALL FEES AND OBTAIN ALL PERMITS FOR RESTORATION. CONTRACTOR IS TO RESTORE ALL DAMAGED STRUCTURES AND UTILITIES TO THE SATISFACTION OF THE FACILITY OWNER OR THE GOVERNING BODY, IN THE EVENT THAT DAMAGE OCCURS.
30. USE EXTREME CAUTION NEAR ALL GAS FACILITIES DURING CONSTRUCTION AND RELATED EXCAVATION ACTIVITIES, HAND EXCAVATION IS REQUIRED TO VERIFY THE HORIZONTAL AND VERTICAL LOCATION OF GAS MAIN(S) PRIOR TO CROSSING AND WORKING WITHIN 3 FEET OF ALL GAS FACILITIES. A MINIMUM OF 3 FEET HORIZONTAL EDGE TO EDGE CLEARANCE IS REQUIRED FOR GAS MAINS WITH DIAMETERS OF 16 INCHES OR SMALLER, AND 5 FEET EDGE TO EDGE CLEARANCE FOR GAS MAINS WITH DIAMETERS 18 INCHES AND LARGER IN DIAMETER. THE USE OF CONCRETE, FLOW FILL, OR THE LIKE IS PROHIBITED WITHIN 24 INCHES OF ALL GAS FACILITIES, NOR SHALL IT ENCASE ANY GAS FACILITY. SAND IS TO BE USED AS A BUFFER BETWEEN FLOWABLE FILL AND ALL GAS FACILITIES, ANY DAMAGE TO GAS FACILITIES SHALL BE THE RESPONSIBILITY OF THE INSTALLING UTILITY AND THEIR CONTRACTORS.

metronet™

3701 COMMUNICATIONS WAY
EVANSVILLE, IN, 47715

Fullerton
DESIGN DEVELOP CONSTRUCT

1100 E. WOODFIELD ROAD, SUITE 500
SCHAUMBURG, ILLINOIS 60173
TEL: 847-908-8400
DESIGN FIRM NO. 184.008202-0006
www.fullerton-us.com

REV	DATE	DESCRIPTION	BY
A	08/23/23	ISSUED FOR REVIEW	NS
B	08/29/23	REVISED	NS

I HEREBY CERTIFY THAT THESE DRAWINGS WERE PREPARED BY ME OR UNDER MY DIRECT SUPERVISION AND CONTROL, AND TO THE BEST OF MY KNOWLEDGE AND BELIEF COMPLY WITH THE REQUIREMENTS OF ALL APPLICABLE CODES.

TASK NAME
WILC013-U-S5

TASK DESCRIPTION
FIBE OPTIC CONDUIT PLACEMENT

PROJECT AREA
LACROSSE, WI, USA

SHEET SCALE
N.T.S.

SHEET TITLE
GENERAL NOTES

GRID NUMBER

SHEET NUMBER
GN-1



metronet

3701 COMMUNICATIONS WAY
EVANSVILLE, IN, 47715



1100 E. WOODFIELD ROAD, SUITE 500
SCHAUMBURG, ILLINOIS 60173
TEL: 847-908-8400
DESIGN FIRM NO. 184.008202-0006
www.fullerton-us.com

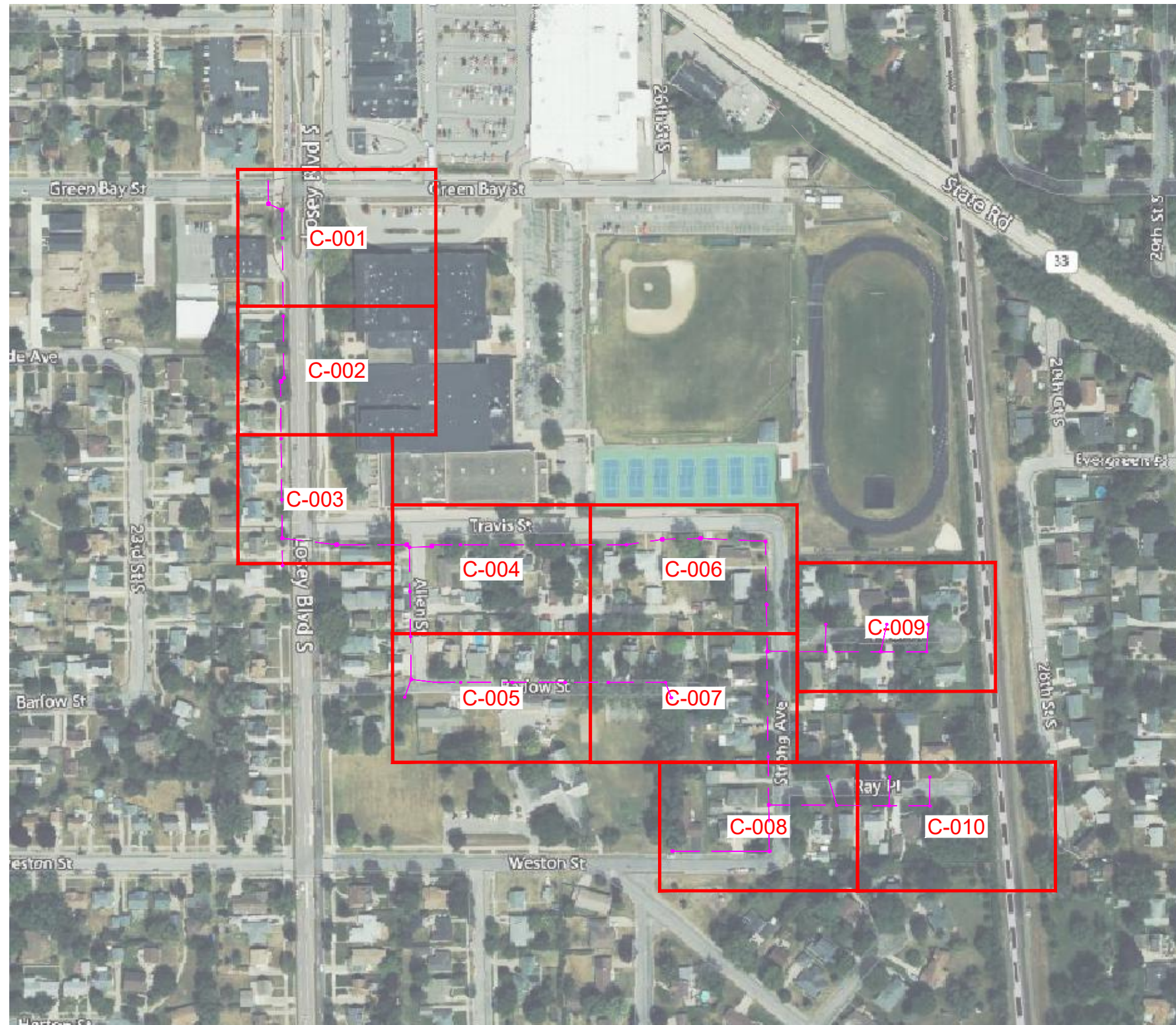

REV	DATE	DESCRIPTION	BY
A	08/23/23	ISSUED FOR REVIEW	NS
B	08/29/23	REVISED	NS

I HEREBY CERTIFY THAT THESE DRAWINGS WERE PREPARED BY ME OR UNDER MY DIRECT SUPERVISION AND CONTROL, AND TO THE BEST OF MY KNOWLEDGE AND BELIEF COMPLY WITH THE REQUIREMENTS OF ALL APPLICABLE CODES.

TASK NAME
WILC013-U-S5

TASK DESCRIPTION
**FIBE OPTIC CONDUIT
PLACEMENT**

PROJECT AREA
LACROSSE, WI, USA

SHEET SCALE
N.T.S.

SHEET TITLE
MAP

GRID NUMBER

SHEET NUMBER
MAP-1

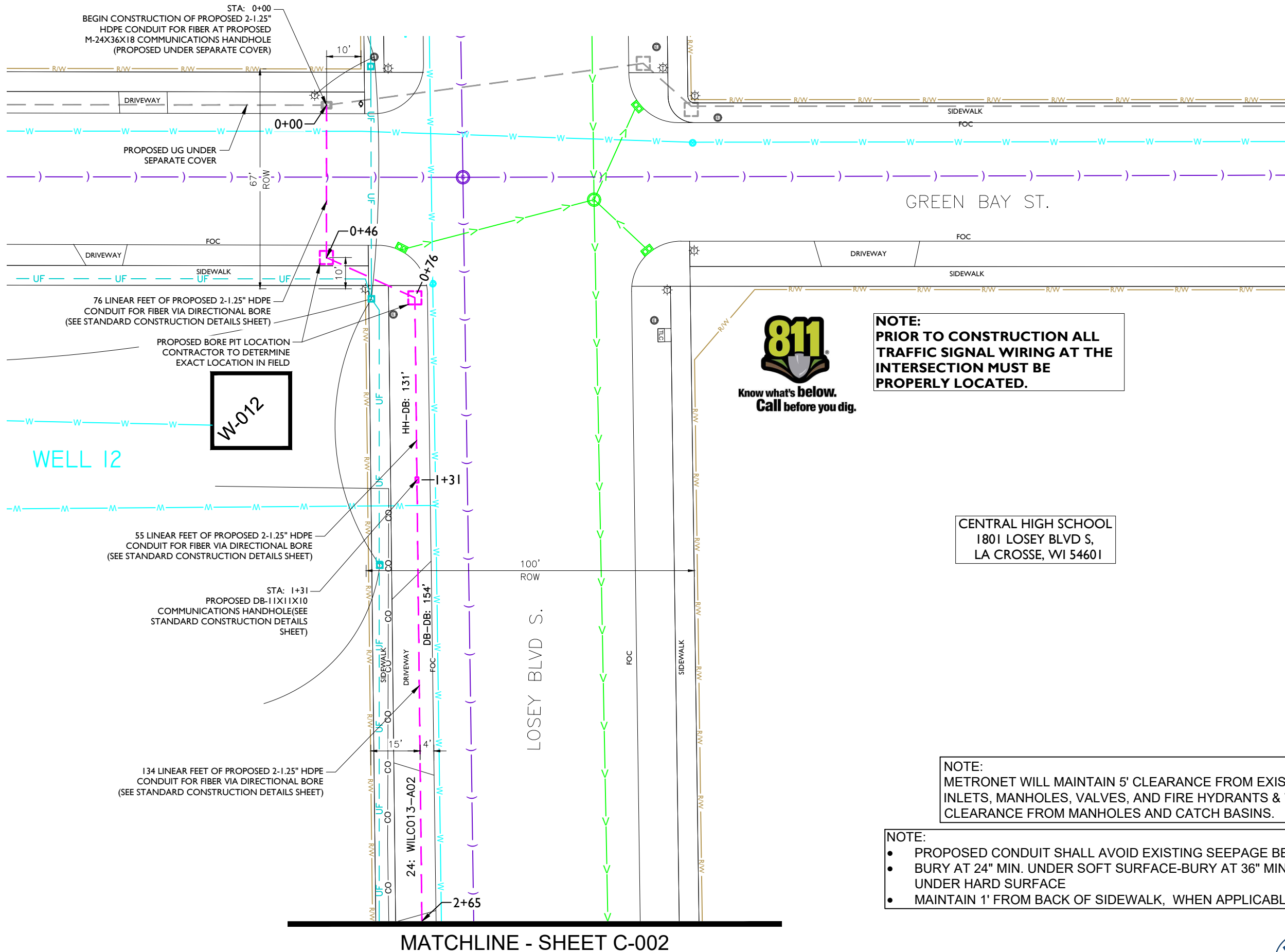

NOTE:
PRIOR TO CONSTRUCTION ALL
TRAFFIC SIGNAL WIRING AT THE
INTERSECTION MUST BE
PROPERLY LOCATED.

CENTRAL HIGH SCHOOL
1801 LOSEY BLVD S,
LA CROSSE, WI 54601

NOTE:
METRONET WILL MAINTAIN 5' CLEARANCE FROM EXISTING
INLETS, MANHOLES, VALVES, AND FIRE HYDRANTS & 7.5'
CLEARANCE FROM MANHOLES AND CATCH BASINS.

NOTE:

- PROPOSED CONDUIT SHALL AVOID EXISTING SEEPAGE BEDS
- BURY AT 24" MIN. UNDER SOFT SURFACE-BURY AT 36" MIN. UNDER HARD SURFACE
- MAINTAIN 1' FROM BACK OF SIDEWALK, WHEN APPLICABLE.

REV	DATE	DESCRIPTION	BY
A	08/23/23	ISSUED FOR REVIEW	NS
B	08/29/23	REVISED	NS

I HEREBY CERTIFY THAT THESE DRAWINGS WERE PREPARED BY ME OR UNDER MY DIRECT SUPERVISION AND CONTROL, AND TO THE BEST OF MY KNOWLEDGE AND BELIEF COMPLY WITH THE REQUIREMENTS OF ALL APPLICABLE CODES.

TASK NAME	WILC013-U-S5
TASK DESCRIPTION	FIBRE OPTIC CONDUIT PLACEMENT
PROJECT AREA	LACROSSE, WI, USA
SHEET SCALE	1" = 30'-0"
SHEET TITLE	DESIGN LAYOUT
GRID NUMBER	
SHEET NUMBER	C-001



MATCHLINE - SHEET C-001

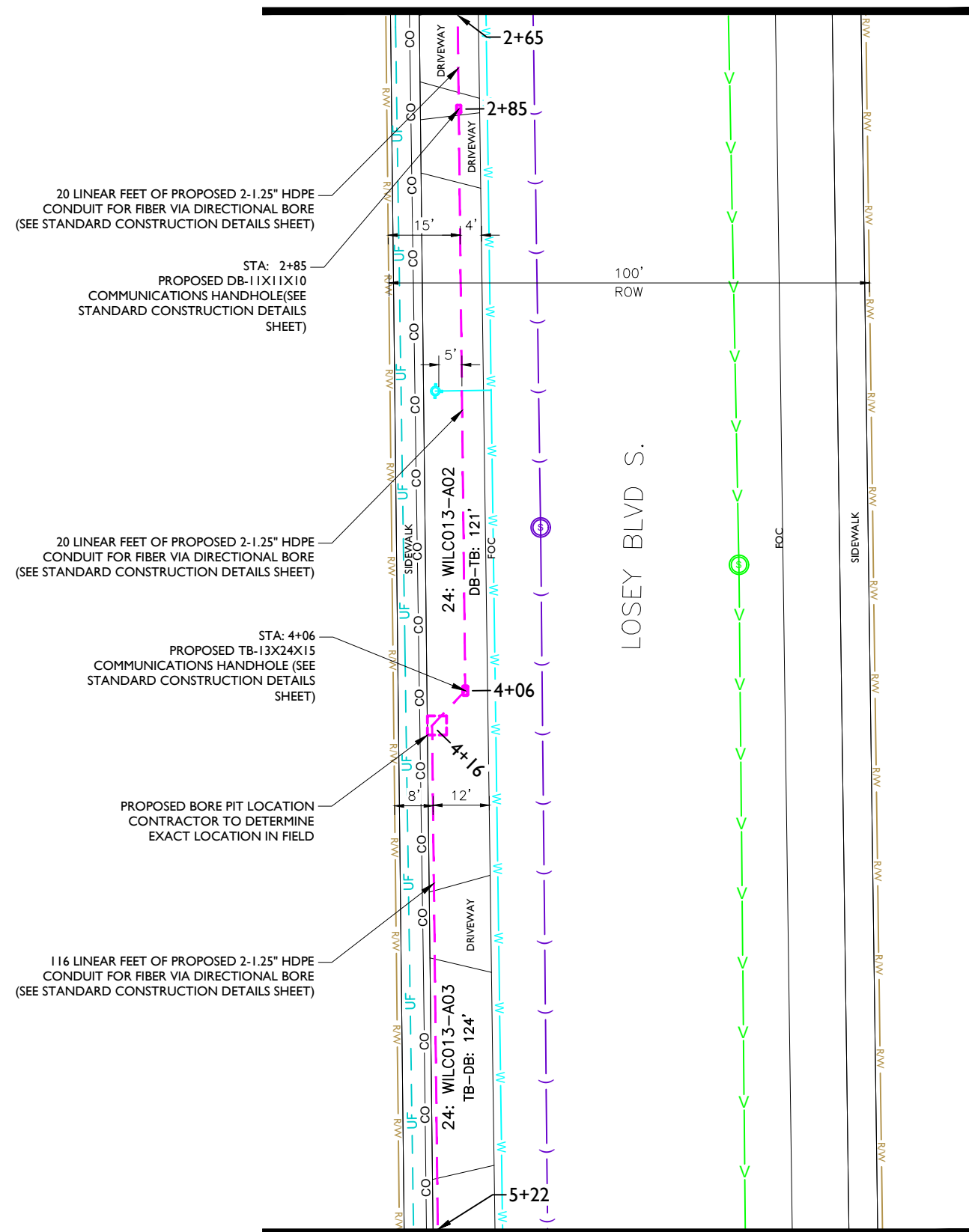

MATCHLINE - SHEET C-003

- NOTE:
- PROPOSED CONDUIT SHALL AVOID EXISTING SEEPAGE BEDS
 - BURY AT 24" MIN. UNDER SOFT SURFACE-BURY AT 36" MIN. UNDER HARD SURFACE
 - MAINTAIN 1' FROM BACK OF SIDEWALK, WHEN APPLICABLE.

- NOTE:
- METRONET WILL MAINTAIN 5' CLEARANCE FROM EXISTING INLETS, MANHOLES, VALVES, AND FIRE HYDRANTS & 7.5' CLEARANCE FROM MANHOLES AND CATCH BASINS.



metronet
 3701 COMMUNICATIONS WAY
 EVANSVILLE, IN, 47715

Fullerton
 DESIGN DEVELOP CONSTRUCT

1100 E. WOODFIELD ROAD, SUITE 500
 SCHAUMBURG, ILLINOIS 60173
 TEL: 847-908-8400
 DESIGN FIRM NO. 184.008202-0006
 www.fullerton-us.com

REV	DATE	DESCRIPTION	BY
A	08/23/23	ISSUED FOR REVIEW	NS
B	08/29/23	REVISED	NS

I HEREBY CERTIFY THAT THESE DRAWINGS WERE PREPARED BY ME OR UNDER MY DIRECT SUPERVISION AND CONTROL, AND TO THE BEST OF MY KNOWLEDGE AND BELIEF COMPLY WITH THE REQUIREMENTS OF ALL APPLICABLE CODES.

TASK NAME
WILC013-U-S5

TASK DESCRIPTION
FIBRE OPTIC CONDUIT PLACEMENT

PROJECT AREA
 LACROSSE, WI, USA

SHEET SCALE
 1" = 30'-0"

SHEET TITLE
DESIGN LAYOUT

GRID NUMBER

SHEET NUMBER
C-002

MATCHLINE - SHEET C-002

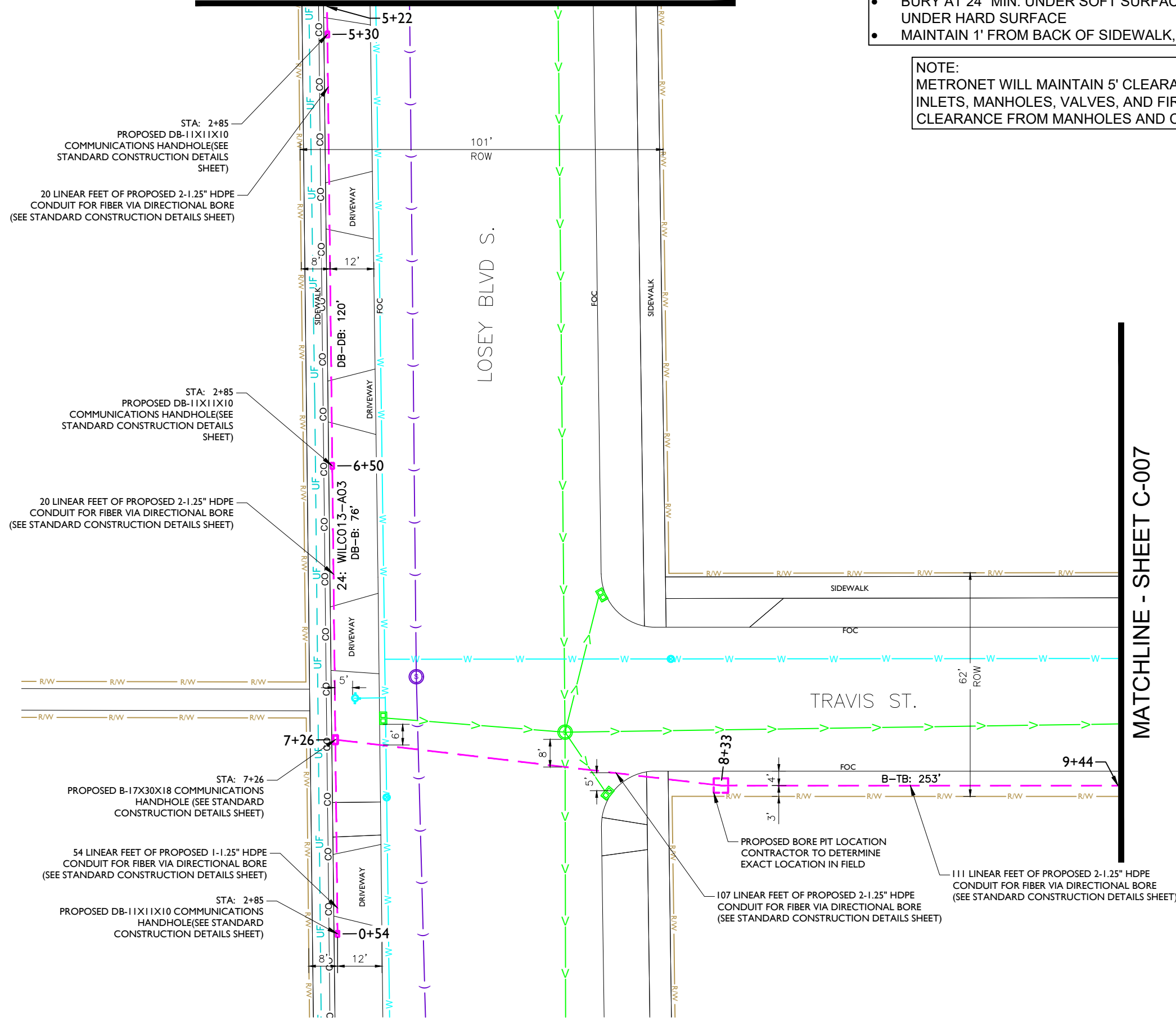

NOTE:
 • PROPOSED CONDUIT SHALL AVOID EXISTING SEEPAGE BEDS
 • BURY AT 24" MIN. UNDER SOFT SURFACE-BURY AT 36" MIN. UNDER HARD SURFACE
 • MAINTAIN 1' FROM BACK OF SIDEWALK, WHEN APPLICABLE.

NOTE:
 METRONET WILL MAINTAIN 5' CLEARANCE FROM EXISTING INLETS, MANHOLES, VALVES, AND FIRE HYDRANTS & 7.5' CLEARANCE FROM MANHOLES AND CATCH BASINS.

STA: 2+85
 PROPOSED DB-11X11X10 COMMUNICATIONS HANDHOLE(SEE STANDARD CONSTRUCTION DETAILS SHEET)
 20 LINEAR FEET OF PROPOSED 2-1.25" HDPE CONDUIT FOR FIBER VIA DIRECTIONAL BORE (SEE STANDARD CONSTRUCTION DETAILS SHEET)

STA: 2+85
 PROPOSED DB-11X11X10 COMMUNICATIONS HANDHOLE(SEE STANDARD CONSTRUCTION DETAILS SHEET)
 20 LINEAR FEET OF PROPOSED 2-1.25" HDPE CONDUIT FOR FIBER VIA DIRECTIONAL BORE (SEE STANDARD CONSTRUCTION DETAILS SHEET)

STA: 7+26
 PROPOSED B-17X30X18 COMMUNICATIONS HANDHOLE (SEE STANDARD CONSTRUCTION DETAILS SHEET)

54 LINEAR FEET OF PROPOSED 1-1.25" HDPE CONDUIT FOR FIBER VIA DIRECTIONAL BORE (SEE STANDARD CONSTRUCTION DETAILS SHEET)

STA: 2+85
 PROPOSED DB-11X11X10 COMMUNICATIONS HANDHOLE(SEE STANDARD CONSTRUCTION DETAILS SHEET)

PROPOSED BORE PIT LOCATION CONTRACTOR TO DETERMINE EXACT LOCATION IN FIELD
 107 LINEAR FEET OF PROPOSED 2-1.25" HDPE CONDUIT FOR FIBER VIA DIRECTIONAL BORE (SEE STANDARD CONSTRUCTION DETAILS SHEET)

111 LINEAR FEET OF PROPOSED 2-1.25" HDPE CONDUIT FOR FIBER VIA DIRECTIONAL BORE (SEE STANDARD CONSTRUCTION DETAILS SHEET)

metronet
 3701 COMMUNICATIONS WAY
 EVANSVILLE, IN, 47715

Fullerton
 DESIGN DEVELOP CONSTRUCT
 1100 E. WOODFIELD ROAD, SUITE 500
 SCHAUMBURG, ILLINOIS 60173
 TEL: 847-908-8400
 DESIGN FIRM NO. 184.008202-0006
 www.fullerton-us.com

REV	DATE	DESCRIPTION	BY
A	08/23/23	ISSUED FOR REVIEW	NS
B	08/29/23	REVISED	NS

I HEREBY CERTIFY THAT THESE DRAWINGS WERE PREPARED BY ME OR UNDER MY DIRECT SUPERVISION AND CONTROL, AND TO THE BEST OF MY KNOWLEDGE AND BELIEF COMPLY WITH THE REQUIREMENTS OF ALL APPLICABLE CODES.

TASK NAME
WILC013-U-S5

TASK DESCRIPTION
FIBRE OPTIC CONDUIT PLACEMENT

PROJECT AREA
 LACROSSE, WI, USA

SHEET SCALE
 1" = 30'-0"

SHEET TITLE
DESIGN LAYOUT

GRID NUMBER

SHEET NUMBER
C-003



MATCHLINE - SHEET C-003

MATCHLINE - SHEET C-006

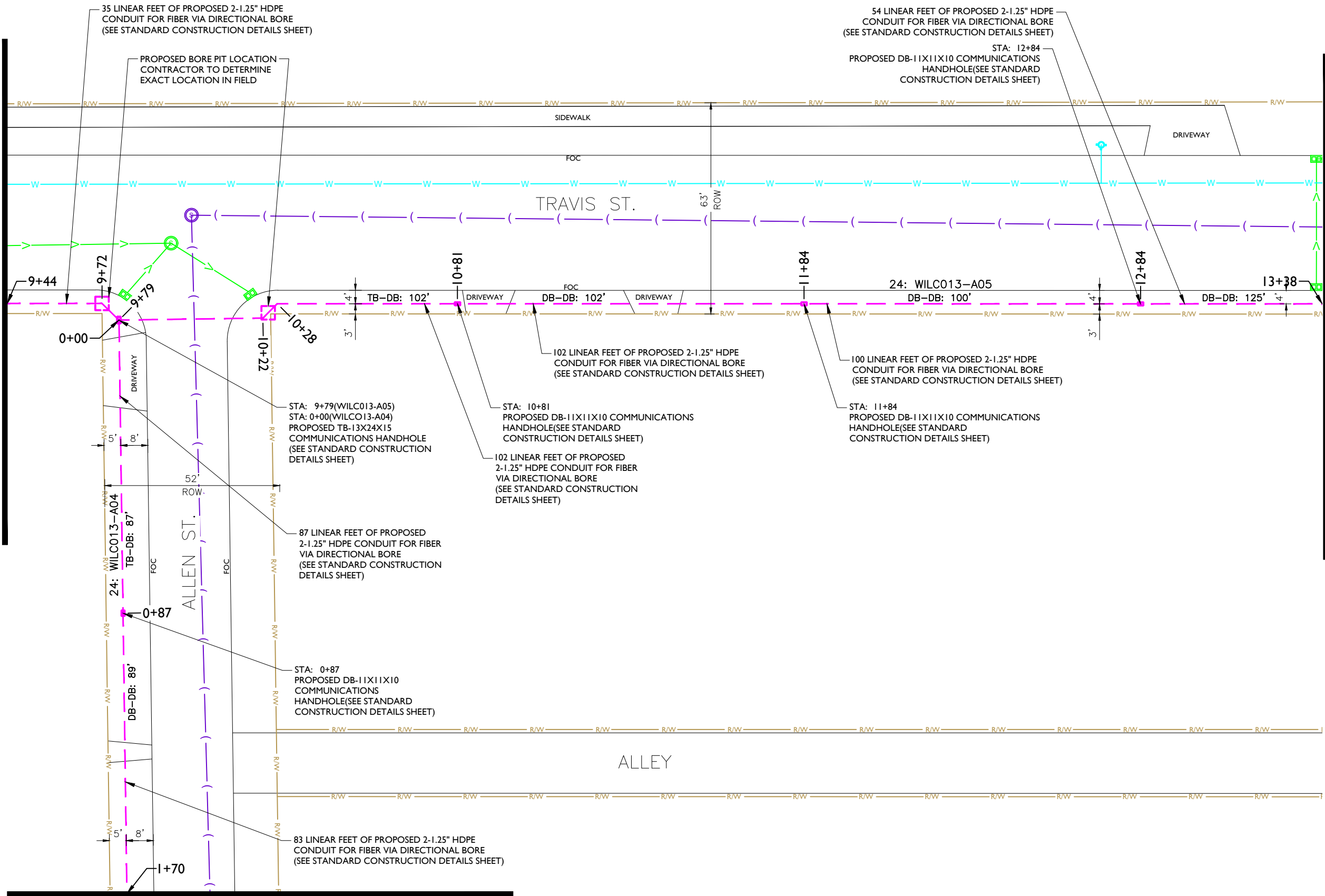

MATCHLINE - SHEET C-005

- NOTE:
- PROPOSED CONDUIT SHALL AVOID EXISTING SEEPAGE BEDS
 - BURY AT 24" MIN. UNDER SOFT SURFACE-BURY AT 36" MIN. UNDER HARD SURFACE
 - MAINTAIN 1' FROM BACK OF SIDEWALK, WHEN APPLICABLE.

- NOTE:
- METRONET WILL MAINTAIN 5' CLEARANCE FROM EXISTING INLETS, MANHOLES, VALVES, AND FIRE HYDRANTS & 7.5' CLEARANCE FROM MANHOLES AND CATCH BASINS.



metronet
3701 COMMUNICATIONS WAY
EVANSVILLE, IN, 47715

Fullerton
DESIGN DEVELOP CONSTRUCT

1100 E. WOODFIELD ROAD, SUITE 500
SCHAUMBURG, ILLINOIS 60173
TEL: 847-908-8400
DESIGN FIRM NO. 184.008202-0006
www.fullerton-us.com

REV	DATE	DESCRIPTION	BY
A	08/23/23	ISSUED FOR REVIEW	NS
B	08/29/23	REVISED	NS

I HEREBY CERTIFY THAT THESE DRAWINGS WERE PREPARED BY ME OR UNDER MY DIRECT SUPERVISION AND CONTROL, AND TO THE BEST OF MY KNOWLEDGE AND BELIEF COMPLY WITH THE REQUIREMENTS OF ALL APPLICABLE CODES.

TASK NAME
WILC013-U-S5

TASK DESCRIPTION
FIBRE OPTIC CONDUIT PLACEMENT

PROJECT AREA
LACROSSE, WI, USA

SHEET SCALE
1" = 30'-0"

SHEET TITLE
DESIGN LAYOUT

GRID NUMBER

SHEET NUMBER
C-004

MATCHLINE - SHEET C-004

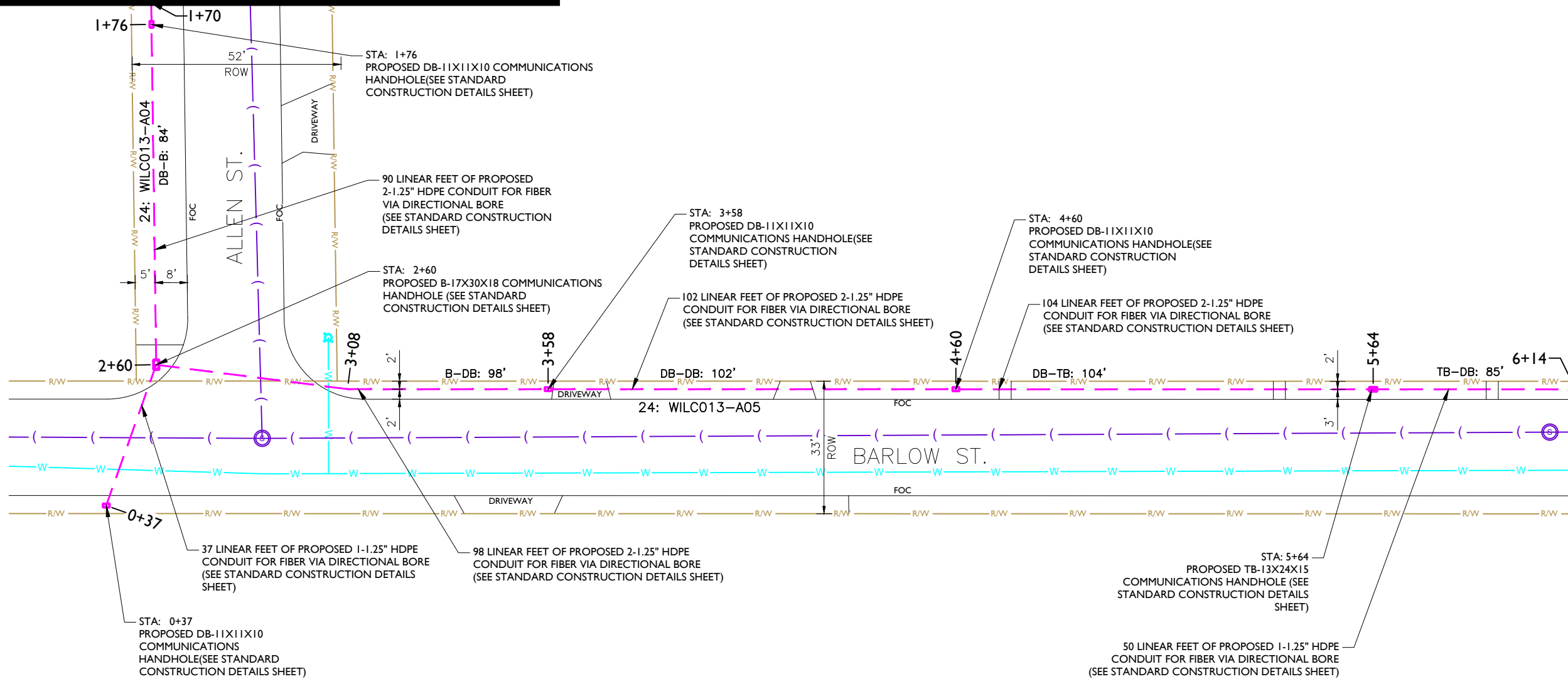

MATCHLINE - SHEET C-008

REV	DATE	DESCRIPTION	BY
A	08/23/23	ISSUED FOR REVIEW	NS
B	08/29/23	REVISED	NS

I HEREBY CERTIFY THAT THESE DRAWINGS WERE PREPARED BY ME OR UNDER MY DIRECT SUPERVISION AND CONTROL, AND TO THE BEST OF MY KNOWLEDGE AND BELIEF COMPLY WITH THE REQUIREMENTS OF ALL APPLICABLE CODES.

TASK NAME	WILCO13-U-S5
TASK DESCRIPTION	FIBRE OPTIC CONDUIT PLACEMENT
PROJECT AREA	LACROSSE, WI, USA
SHEET SCALE	1" = 30'-0"
SHEET TITLE	DESIGN LAYOUT
GRID NUMBER	
SHEET NUMBER	C-005

- NOTE:
- PROPOSED CONDUIT SHALL AVOID EXISTING SEEPAGE BEDS
 - BURY AT 24" MIN. UNDER SOFT SURFACE-BURY AT 36" MIN. UNDER HARD SURFACE
 - MAINTAIN 1' FROM BACK OF SIDEWALK, WHEN APPLICABLE.

- NOTE:
- METRONET WILL MAINTAIN 5' CLEARANCE FROM EXISTING INLETS, MANHOLES, VALVES, AND FIRE HYDRANTS & 7.5' CLEARANCE FROM MANHOLES AND CATCH BASINS.



REV	DATE	DESCRIPTION	BY
A	08/23/23	ISSUED FOR REVIEW	NS
B	08/29/23	REVISED	NS

I HEREBY CERTIFY THAT THESE DRAWINGS WERE PREPARED BY ME OR UNDER MY DIRECT SUPERVISION AND CONTROL, AND TO THE BEST OF MY KNOWLEDGE AND BELIEF COMPLY WITH THE REQUIREMENTS OF ALL APPLICABLE CODES.

TASK NAME

WILC013-U-S5

TASK DESCRIPTION
**FIBRE OPTIC CONDUIT
PLACEMENT**

PROJECT AREA
LACROSSE, WI, USA

SHEET SCALE
1" = 30'-0"

SHEET TITLE
DESIGN LAYOUT

GRID NUMBER

SHEET NUMBER
C-006

MATCHLINE - SHEET C-004

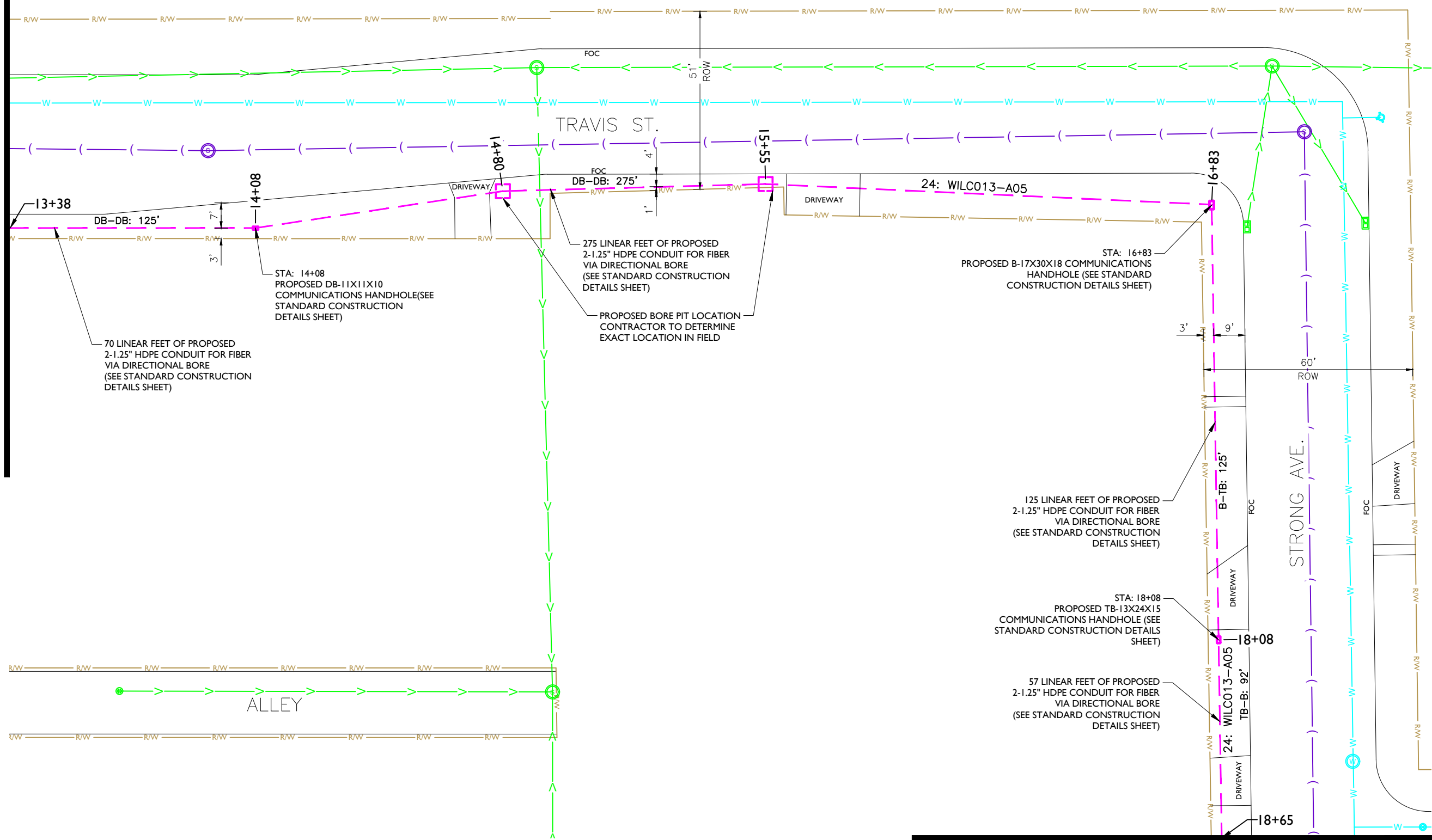

MATCHLINE - SHEET C-007

- NOTE:
- PROPOSED CONDUIT SHALL AVOID EXISTING SEEPAGE BEDS
 - BURY AT 24" MIN. UNDER SOFT SURFACE-BURY AT 36" MIN. UNDER HARD SURFACE
 - MAINTAIN 1' FROM BACK OF SIDEWALK, WHEN APPLICABLE.

- NOTE:
- METRONET WILL MAINTAIN 5' CLEARANCE FROM EXISTING INLETS, MANHOLES, VALVES, AND FIRE HYDRANTS & 7.5' CLEARANCE FROM MANHOLES AND CATCH BASINS.



MATCHLINE - SHEET C-005

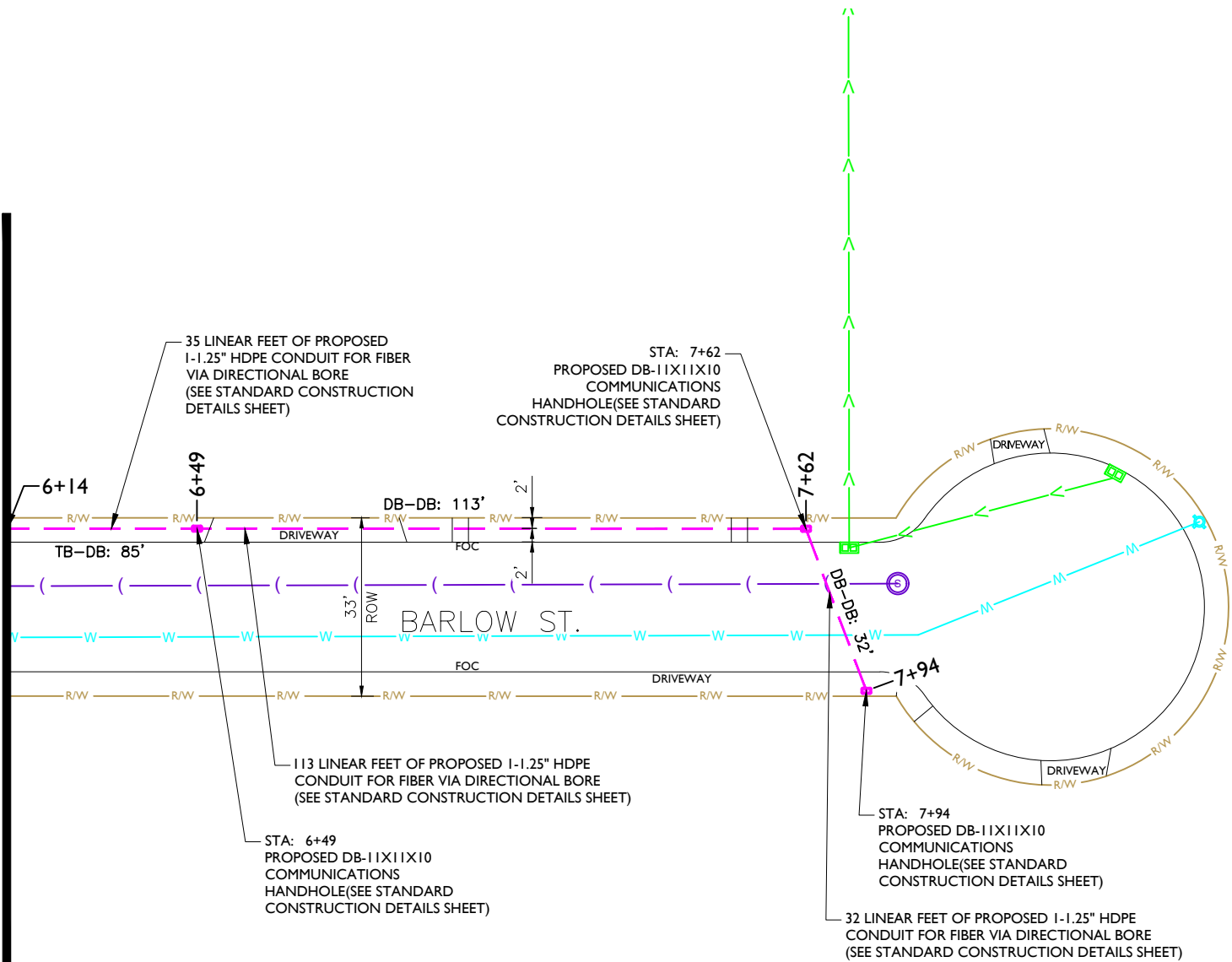

- NOTE:
- PROPOSED CONDUIT SHALL AVOID EXISTING SEEPAGE BEDS
 - BURY AT 24" MIN. UNDER SOFT SURFACE-BURY AT 36" MIN. UNDER HARD SURFACE
 - MAINTAIN 1' FROM BACK OF SIDEWALK, WHEN APPLICABLE.

MATCHLINE - SHEET C-006

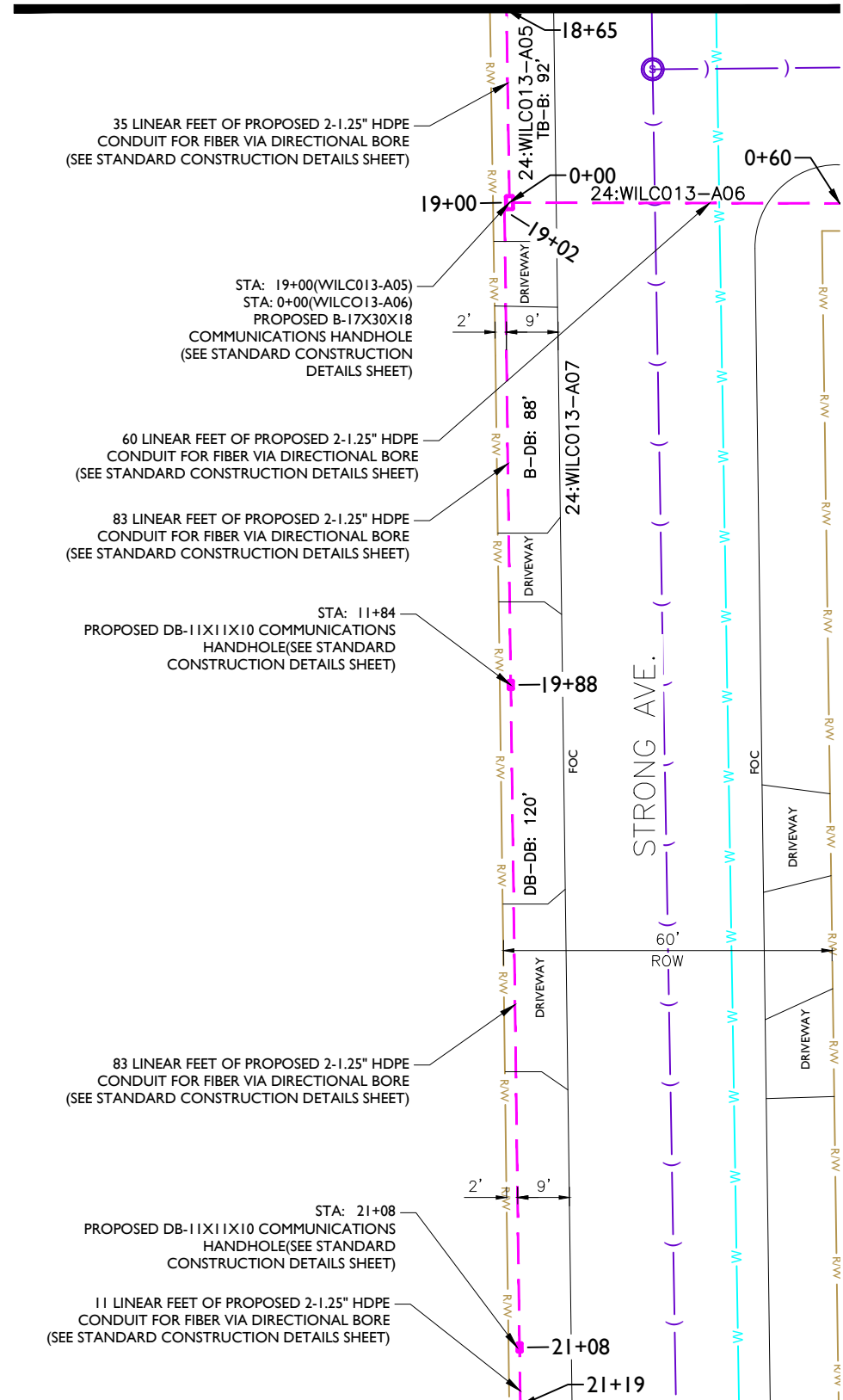

- NOTE:
- METRONET WILL MAINTAIN 5' CLEARANCE FROM EXISTING INLETS, MANHOLES, VALVES, AND FIRE HYDRANTS & 7.5' CLEARANCE FROM MANHOLES AND CATCH BASINS.

metronet
3701 COMMUNICATIONS WAY
EVANSVILLE, IN, 47715

Fullerton
DESIGN DEVELOP CONSTRUCT
1100 E. WOODFIELD ROAD, SUITE 500
SCHAUMBURG, ILLINOIS 60173
TEL: 847-908-8400
DESIGN FIRM NO. 184.008202-0006
www.fullerton-us.com

REV	DATE	DESCRIPTION	BY
A	08/23/23	ISSUED FOR REVIEW	NS
B	08/29/23	REVISED	NS

I HEREBY CERTIFY THAT THESE DRAWINGS WERE PREPARED BY ME OR UNDER MY DIRECT SUPERVISION AND CONTROL, AND TO THE BEST OF MY KNOWLEDGE AND BELIEF COMPLY WITH THE REQUIREMENTS OF ALL APPLICABLE CODES.

TASK NAME
WILCO13-U-S5

TASK DESCRIPTION
FIBRE OPTIC CONDUIT PLACEMENT

PROJECT AREA
LACROSSE, WI, USA

SHEET SCALE
1" = 30'-0"

SHEET TITLE
DESIGN LAYOUT

GRID NUMBER

SHEET NUMBER
C-007



MATCHLINE - SHEET C-007

metronet

3701 COMMUNICATIONS WAY
EVANSVILLE, IN, 47715

Fullerton
DESIGN DEVELOP CONSTRUCT

1100 E. WOODFIELD ROAD, SUITE 500
SCHAUMBURG, ILLINOIS 60173
TEL: 847-908-8400
DESIGN FIRM NO. 184.008202-0006
www.fullerton-us.com

MATCHLINE - SHEET C-010

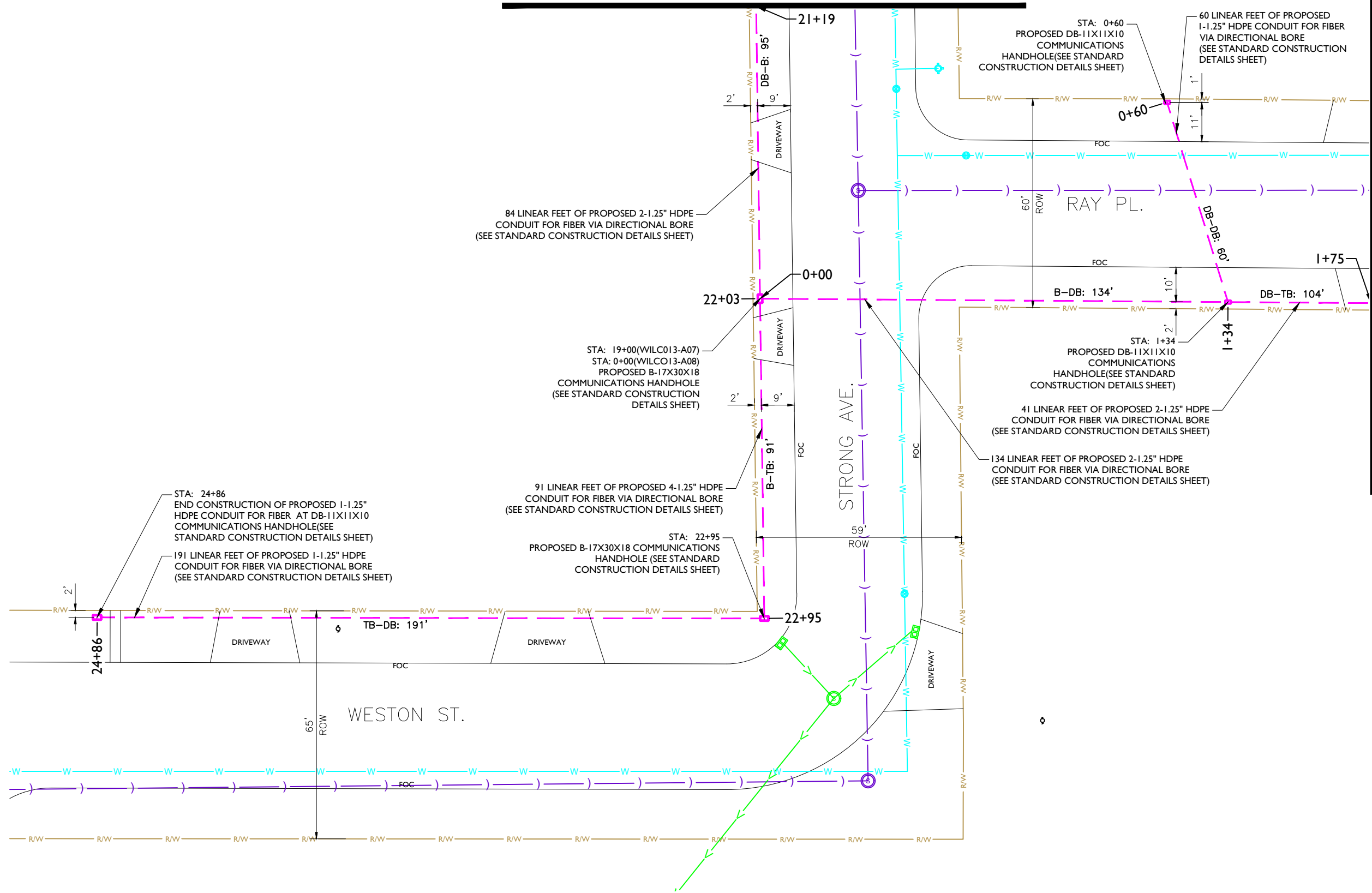

REV	DATE	DESCRIPTION	BY
A	08/23/23	ISSUED FOR REVIEW	NS
B	08/29/23	REVISED	NS

I HEREBY CERTIFY THAT THESE DRAWINGS WERE PREPARED BY ME OR UNDER MY DIRECT SUPERVISION AND CONTROL, AND TO THE BEST OF MY KNOWLEDGE AND BELIEF COMPLY WITH THE REQUIREMENTS OF ALL APPLICABLE CODES.

TASK NAME
WILC013-U-S5

TASK DESCRIPTION
FIBE OPTIC CONDUIT PLACEMENT

PROJECT AREA
LACROSSE, WI, USA

SHEET SCALE
1" = 30'-0"

SHEET TITLE
DESIGN LAYOUT

GRID NUMBER

SHEET NUMBER
C-008

- NOTE:
- PROPOSED CONDUIT SHALL AVOID EXISTING SEEPAGE BEDS
 - BURY AT 24" MIN. UNDER SOFT SURFACE-BURY AT 36" MIN. UNDER HARD SURFACE
 - MAINTAIN 1' FROM BACK OF SIDEWALK, WHEN APPLICABLE.

- NOTE:
- METRONET WILL MAINTAIN 5' CLEARANCE FROM EXISTING INLETS, MANHOLES, VALVES, AND FIRE HYDRANTS & 7.5' CLEARANCE FROM MANHOLES AND CATCH BASINS.



REV	DATE	DESCRIPTION	BY
A	08/23/23	ISSUED FOR REVIEW	NS
B	08/29/23	REVISED	NS

I HEREBY CERTIFY THAT THESE DRAWINGS WERE PREPARED BY ME OR UNDER MY DIRECT SUPERVISION AND CONTROL, AND TO THE BEST OF MY KNOWLEDGE AND BELIEF COMPLY WITH THE REQUIREMENTS OF ALL APPLICABLE CODES.

TASK NAME

WILC013-U-S5

TASK DESCRIPTION
**FIBRE OPTIC CONDUIT
PLACEMENT**

PROJECT AREA
LACROSSE, WI, USA

SHEET SCALE
1" = 30'-0"

SHEET TITLE
DESIGN LAYOUT

GRID NUMBER

SHEET NUMBER
C-009

MATCHLINE - SHEET C-007

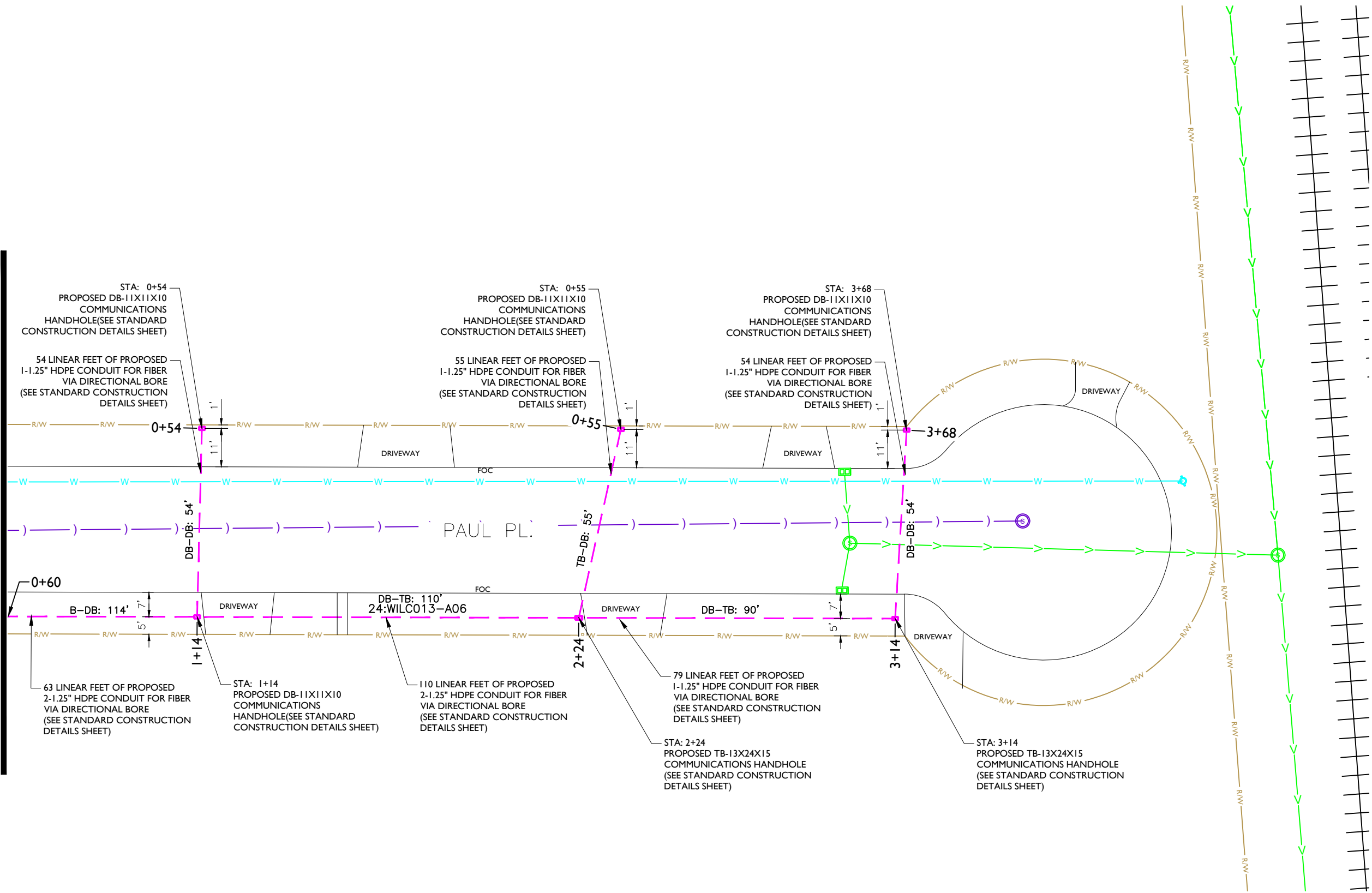

- NOTE:
- PROPOSED CONDUIT SHALL AVOID EXISTING SEEPAGE BEDS
 - BURY AT 24" MIN. UNDER SOFT SURFACE-BURY AT 36" MIN. UNDER HARD SURFACE
 - MAINTAIN 1' FROM BACK OF SIDEWALK, WHEN APPLICABLE.

- NOTE:
- METRONET WILL MAINTAIN 5' CLEARANCE FROM EXISTING INLETS, MANHOLES, VALVES, AND FIRE HYDRANTS & 7.5' CLEARANCE FROM MANHOLES AND CATCH BASINS.



MATCHLINE - SHEET C-008

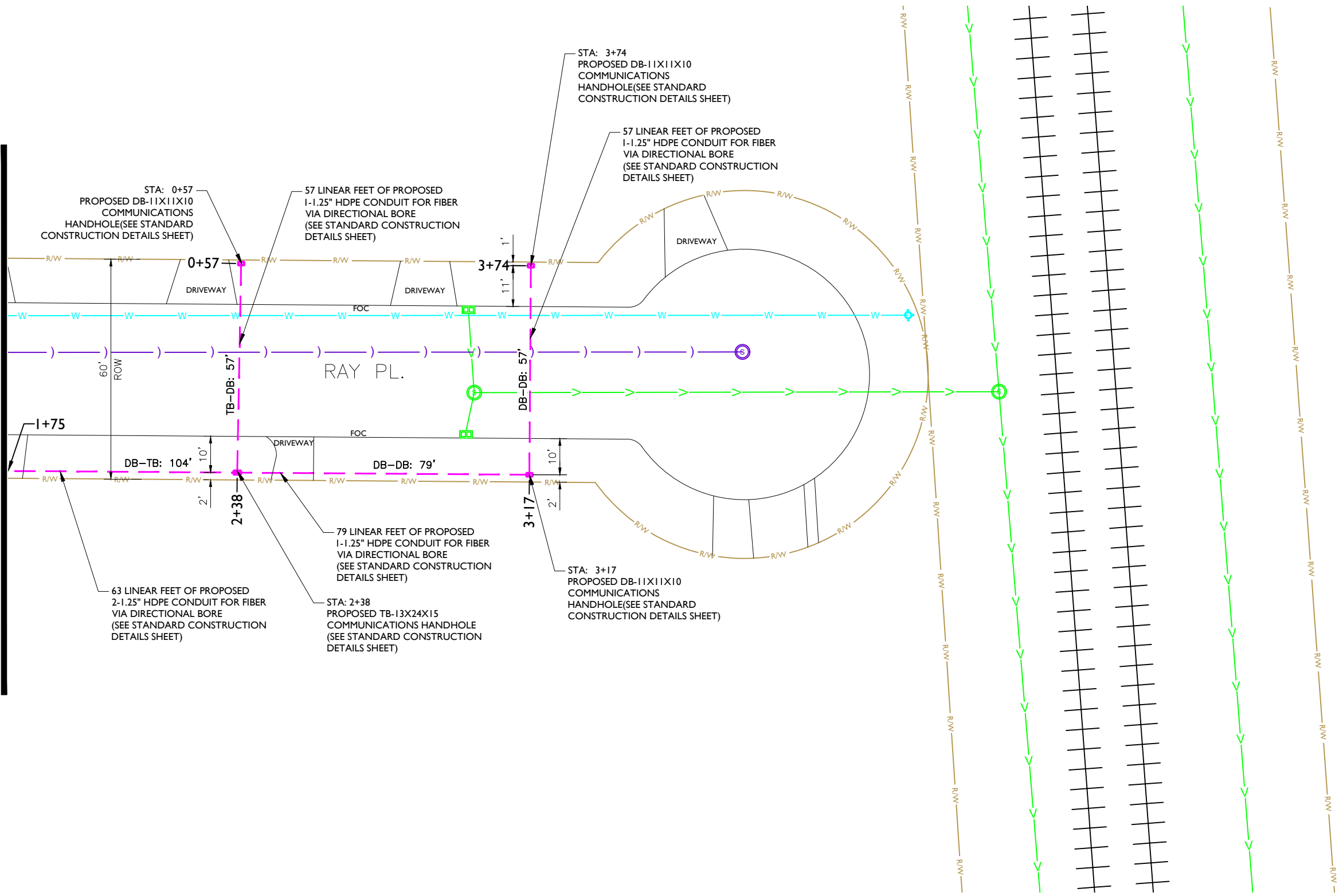

- NOTE:**
- PROPOSED CONDUIT SHALL AVOID EXISTING SEEPAGE BEDS
 - BURY AT 24" MIN. UNDER SOFT SURFACE-BURY AT 36" MIN. UNDER HARD SURFACE
 - MAINTAIN 1' FROM BACK OF SIDEWALK, WHEN APPLICABLE.

- NOTE:**
- METRONET WILL MAINTAIN 5' CLEARANCE FROM EXISTING INLETS, MANHOLES, VALVES, AND FIRE HYDRANTS & 7.5' CLEARANCE FROM MANHOLES AND CATCH BASINS.

metronet
 3701 COMMUNICATIONS WAY
 EVANSVILLE, IN, 47715

Fullerton
 DESIGN DEVELOP CONSTRUCT
 1100 E. WOODFIELD ROAD, SUITE 500
 SCHAUMBURG, ILLINOIS 60173
 TEL: 847-908-8400
 DESIGN FIRM NO. 184.008202-0006
 www.fullerton-us.com

REV	DATE	DESCRIPTION	BY
A	08/23/23	ISSUED FOR REVIEW	NS
B	08/29/23	REVISED	NS

I HEREBY CERTIFY THAT THESE DRAWINGS WERE PREPARED BY ME OR UNDER MY DIRECT SUPERVISION AND CONTROL, AND TO THE BEST OF MY KNOWLEDGE AND BELIEF COMPLY WITH THE REQUIREMENTS OF ALL APPLICABLE CODES.

TASK NAME	WILC013-U-S5
TASK DESCRIPTION	FIBE OPTIC CONDUIT PLACEMENT
PROJECT AREA	LACROSSE, WI, USA
SHEET SCALE	1" = 30'-0"
SHEET TITLE	DESIGN LAYOUT
GRID NUMBER	
SHEET NUMBER	C-010

ADDITIONAL NOTES:

1. EXCEPT AS OTHERWISE NOTED, CONTRACTOR SHALL MAINTAIN A MINIMUM OF 24 INCHES OF SEPARATION FROM EXISTING UTILITIES.
2. CONTRACTOR SHALL POT HOLE EACH UTILITY TO DETERMINE SIZE, LOCATION, AND DEPTH PRIOR TO CROSSING.
3. CONTRACTOR IS CAUTIONED TO PROTECT SEWER MANHOLES, CATCH BASINS, LATERALS AND INLETS.
4. CONTRACTOR WILL PROVIDE BARRICADING TO INSURE CORRECT TRAFFIC CONTROL WHILE MAINTAINING VEHICULAR TRAFFIC AT ALL TIMES.
5. RESTORATION TO BE IN COMPLIANCE WITH APPLICABLE PERMITTING AGENCIES.
6. BONDING AND GROUNDING PER NESC.

PUBLIC UTILITY NOTE:

CONTRACTOR SHALL NOTIFY ALL PUBLIC UTILITY COMPANIES (GAS, ELECTRIC, TELEPHONE, SEWER, WATER, ETC) PRIOR TO COMMENCING ANY CONSTRUCTION. THESE COMPANIES WILL LOCATE, ON THE GROUND, THE LOCATION OF ALL CONDUITS, DUCTS, UNDERGROUND PIPING, ETC., ADJOINING & CROSSING PROPOSED CONSTRUCTION.

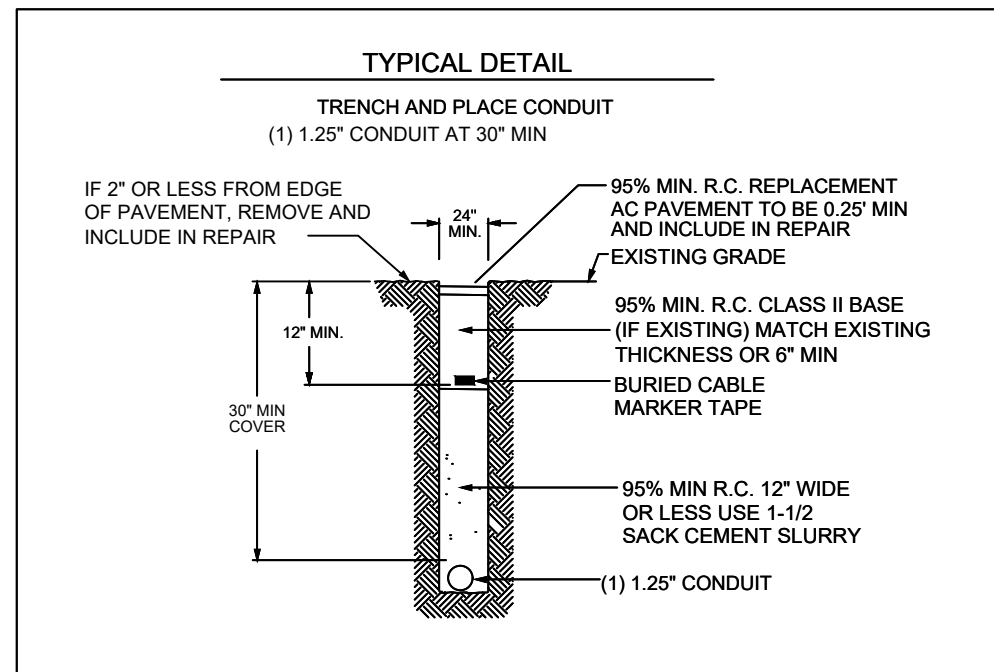
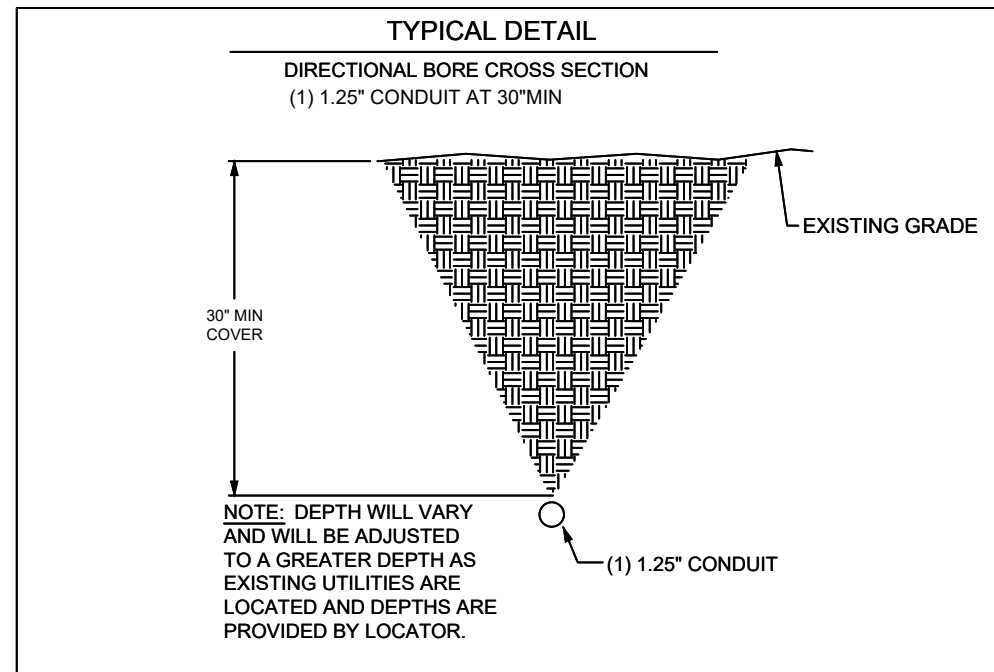

REV	DATE	DESCRIPTION	BY
A	08/23/23	ISSUED FOR REVIEW	NS
B	08/29/23	REVISED	NS

I HEREBY CERTIFY THAT THESE DRAWINGS WERE PREPARED BY ME OR UNDER MY DIRECT SUPERVISION AND CONTROL, AND TO THE BEST OF MY KNOWLEDGE AND BELIEF COMPLY WITH THE REQUIREMENTS OF ALL APPLICABLE CODES.

TASK NAME
WILC013-U-S5

TASK DESCRIPTION
FIBE OPTIC CONDUIT PLACEMENT

PROJECT AREA
 LACROSSE, WI, USA

SHEET SCALE
 N.T.S.

SHEET TITLE
DETAILS

GRID NUMBER

SHEET NUMBER
 D-1

BULK 3 Series

TECHNICAL SPECIFICATIONS

BODY SPECIFICATIONS

Cover Weight 26 lbs [12 kg]
 Pit Weight 63 lbs [29 kg]
 Assembled Weight 89 lbs [41 kg]

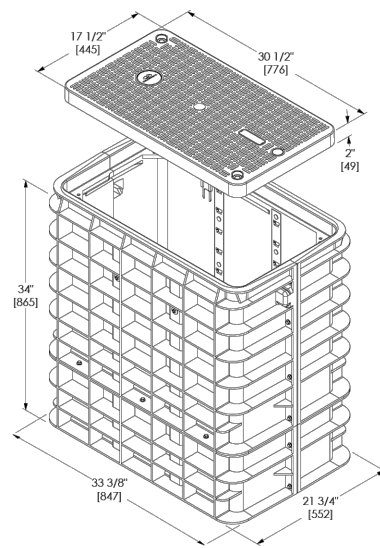
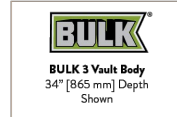

ADDITIONAL BODY DEPTHS

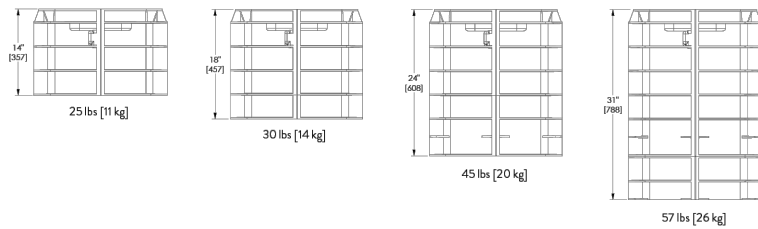

BULK 4 Series

TECHNICAL SPECIFICATIONS

BODY SPECIFICATIONS

Cover Weight 50 lbs [23 kg]
 Pit Weight 82 lbs [37 kg]
 Assembled Weight 132 lbs [60 kg]

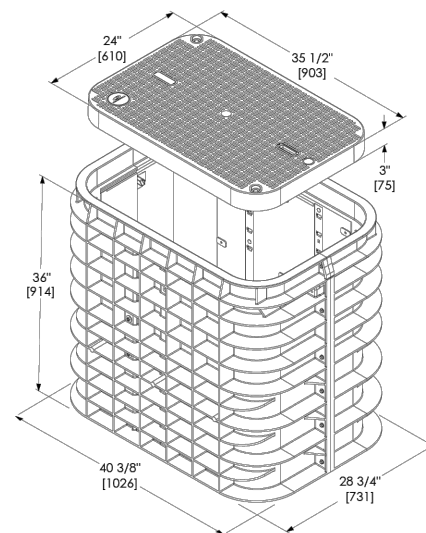
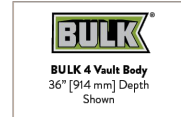

ADDITIONAL BODY DEPTHS

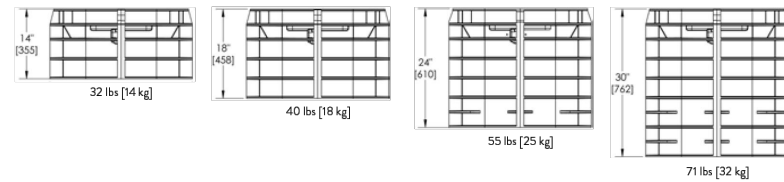

BULK 7 Series

TECHNICAL SPECIFICATIONS

BODY SPECIFICATIONS

Cover Weight (Split 1/2 Cover) 50 lbs [23 kg]
 Pit Weight 129 lbs [59 kg]
 Assembled Weight 229 lbs [105 kg]

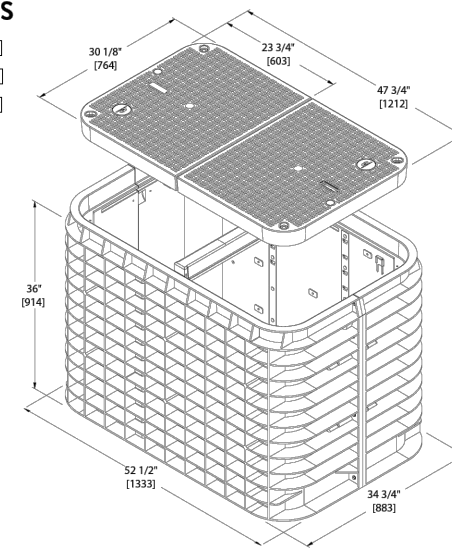

ADDITIONAL BODY DEPTHS

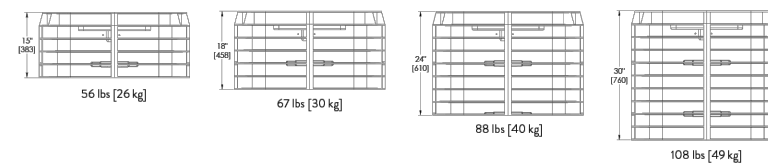

3701 COMMUNICATIONS WAY
 EVANSVILLE, IN, 47715



1100 E. WOODFIELD ROAD, SUITE 500
 SCHAUMBURG, ILLINOIS 60173
 TEL: 847-908-8400
 DESIGN FIRM NO. 184.008202-0006
 www.fullerton-us.com

REV	DATE	DESCRIPTION	BY
A	08/23/23	ISSUED FOR REVIEW	NS
B	08/29/23	REVISED	NS

I HEREBY CERTIFY THAT THESE DRAWINGS WERE PREPARED BY ME OR UNDER MY DIRECT SUPERVISION AND CONTROL, AND TO THE BEST OF MY KNOWLEDGE AND BELIEF COMPLY WITH THE REQUIREMENTS OF ALL APPLICABLE CODES.

TASK NAME

WILC013-U-S5

TASK DESCRIPTION
**FIBE OPTIC CONDUIT
 PLACEMENT**

PROJECT AREA

LACROSSE, WI, USA

SHEET SCALE

N.T.S.

SHEET TITLE

DETAILS

GRID NUMBER

SHEET NUMBER

D-2



DATA SHEET

SGLB-0 NEW SIGNATURE SERIES GRADE LEVEL BOX WITH SELFLOCK™ PROTECTION



SIMPLE AND WORRY FREE PROTECTION



SELFLOCK™ closes and seals with audible "Click"



Captive bolt device opens with only 1/4 turn



Shown with Optional Marker Locate Device

DIMENSIONS

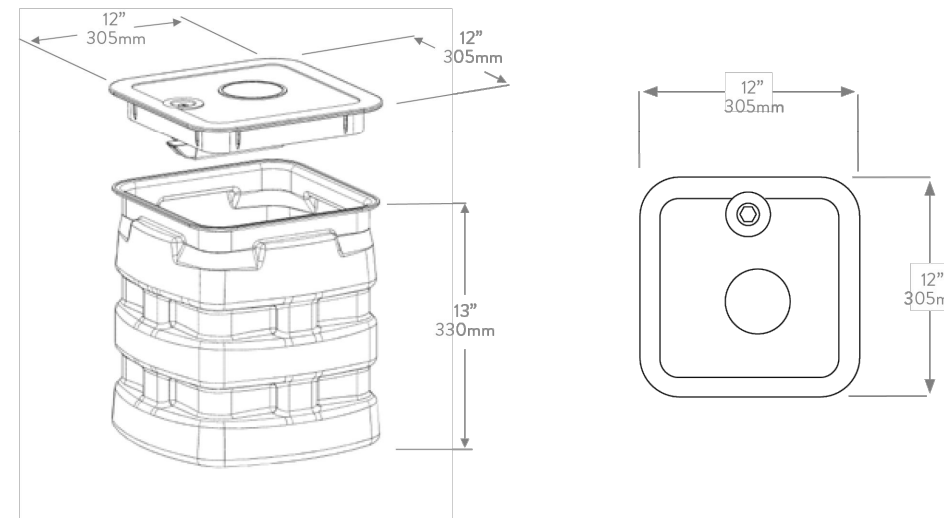

SELFLOCK™

The New Signature Series SGLB High Density Polyethylene (HDPE) grade level box line come standard with Logo Disk and the Patented SELFLOCK™ automatic locking mechanism.

FEATURES

- 13" (330mm) Depth
- No bolts to be lost, misplaced, or not installed back into the unit

- Captive bolt device, that opens with a 1/4 turn
- Press/Push lid closed, and it will automatically lock in place (with an audible "click")
- Protects your investment, and ensures the needed protection for your network
- Eliminates the risk of lids floating off, being throw be lawnmowers (i.e. reduces potentially liability)



CHANNELL

Where The Industry Connects.

WORLDWIDE HEADQUARTERS: Channell Commercial Corporation, Rockwall, TX, United States • Tel 800.423.1863 • Fax 951.296.2322

CANADA: Channell Canada, Inc., Mississauga, ON, Canada • Tel 905.565.1700 • Fax 905.565.8282

EUROPE, MIDDLE EAST, AFRICA: Channell Ltd., Dartford, United Kingdom • Tel 44.1322.312590 • Fax 44.1322.508490

AUSTRALIA, ASIA, PACIFIC RIM: Channell Pty. Ltd., Seven Hills, NSW, Australia • Tel 61.2.8884.4111 • Fax 61.2.8814.8841

www.channell.com

All specifications subject to change without notice. © 2022 Channell Commercial Corporation. All rights reserved.

040822 FRT

metronet™

3701 COMMUNICATIONS WAY
EVANSVILLE, IN, 47715

Fullerton
DESIGN DEVELOP CONSTRUCT

1100 E. WOODFIELD ROAD, SUITE 500
SCHAUMBURG, ILLINOIS 60173
TEL: 847-908-8400
DESIGN FIRM NO. 184.008202-0006
www.fullerton-us.com

REV	DATE	DESCRIPTION	BY
A	08/23/23	ISSUED FOR REVIEW	NS
B	08/29/23	REVISED	NS

I HEREBY CERTIFY THAT THESE DRAWINGS WERE PREPARED BY ME OR UNDER MY DIRECT SUPERVISION AND CONTROL, AND TO THE BEST OF MY KNOWLEDGE AND BELIEF COMPLY WITH THE REQUIREMENTS OF ALL APPLICABLE CODES.

TASK NAME

WILC013-U-S5

TASK DESCRIPTION

FIBE OPTIC CONDUIT
PLACEMENT

PROJECT AREA

LACROSSE, WI, USA

SHEET SCALE

N.T.S.

SHEET TITLE

DETAILS

GRID NUMBER

SHEET NUMBER

D-3

NOTES:

1. CALL FOR LOCATES AT LEAST 72 HOURS IN ADVANCE OF ANY CONSTRUCTION FOR MARKINGS.
2. FOR LABEL AND TAG INFORMATION SEE DRAWING OSP 16.
3. THE VAULT W/ BOTTOM ENTRY ELEVATION VIEW SHOWN BELOW ONLY INDICATES THE BACK FILL REQUIREMENTS NECESSARY FOR VAULTS PLACED IN SIDEWALKS, ETC. (WHERE THEY NEED TO COMPLY WITH ADA REQUIREMENTS). TO ENSURE COMPLIANCE WITH CURRENT ADA REQUIREMENTS, THE HEIGHT OF THE BACK FILL IS SHOWN HELD DOWN TO ALLOW CONCRETE TO FLOW DOWN AND AROUND THE LIFTING LUGS/BOLTS WHICH WILL SERVE AS DOWELS INTO THE FINISHED CONCRETE SLAB.

ADA REQUIREMENTS:

SURFACE LEVEL CRITERIA: NO HEIGHT DIFFERENTIALS WITH A RISE GREATER THAN 1/4" IN HEIGHT. EXCEPTIONS: A HEIGHT DIFFERENTIAL BETWEEN 1/4" AND 1/2" IS ACCEPTABLE IF IT IS BEVELED AT A 2:1 SLOPE, OR A HEIGHT DIFFERENTIAL GREATER THAN 1/2" IS ACCEPTABLE IF IT IS RAMPED WITH A SLOPE OF 8.33% (1X:12H) OR LESS.

UTILITY COVERS SHALL HAVE A SLIP RESISTANT TOP, AS MUCH AS POSSIBLE, AND MEET CHANGES IN LEVEL CRITERIA AS STATED ABOVE.

LIFT HOLES FOR UTILITY COVERS SHALL NOT HAVE AN OPENING GREATER THAN 1/2". PLUGGING OF HOLES GREATER THAN 1/2" WITH A MATERIAL APPROVED BY THE ENGINEER IS ACCEPTABLE AS LONG AS IT IS FLUSH WITH THE COVER SURFACE.

A LEVEL PEDESTRIAN ACCESS ROUTE (PAR) OR WALKWAY SHALL BE PROVIDED ACROSS COMMERCIAL AND RESIDENTIAL ENTRANCES, MEETING THE FOLLOWING CRITERIA:
 - THE WALKWAY IS AT MINIMUM 3' WIDE.
 - CROSS SLOPE OF WALKWAY IS 2% OR LESS.
 - WALKWAY IS AT THE SAME GRADE AS THE ADJACENT ROADWAY.
 - THE WALKWAY DOES NOT HAVE TO BE MARKED, BUT PROVIDES A STRAIGHT LINE BETWEEN THE ADJOINING SIDEWALKS OR RAMPS.
 - THERE IS NOT AN ABRUPT TRANSITION FROM THE DRIVEWAY TO THE ROADWAY FOR VEHICLES, I.E., VEHICLES WILL NOT BOTTOM OUT WHEN DRIVING OVER THE TRANSITION.

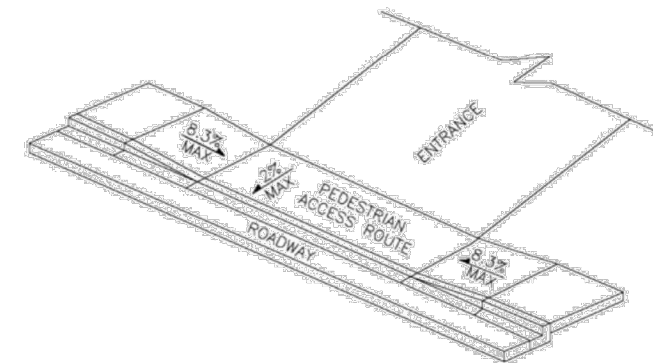
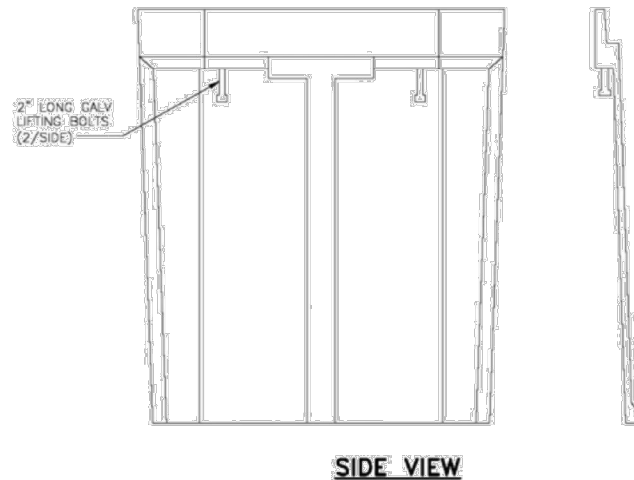
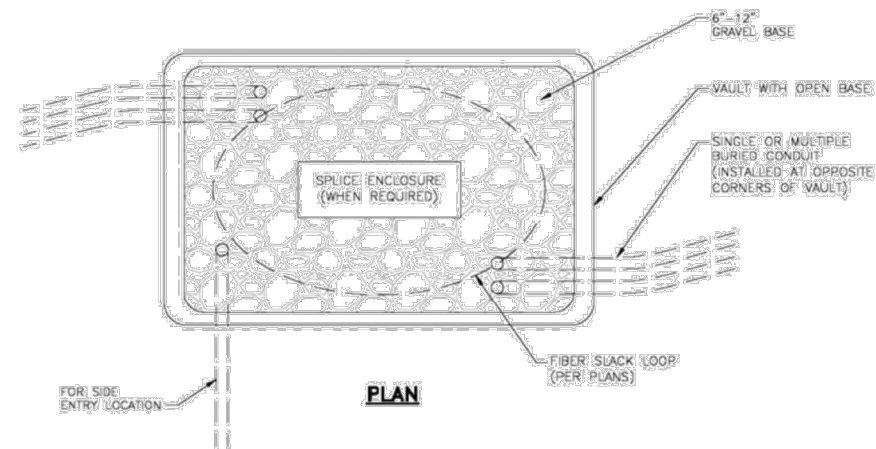

NOTE:

1. ENCLOSURES, BOXES AND COVERS ARE REQUIRED TO MEET OR EXCEED ALL TESTS PROVISIONS OF THE MOST CURRENT ANSI/SCIE 77-2007 "SPECIFICATIONS FOR UNDERGROUND INTEGRITY" FOR TIER 15 OR BETTER.

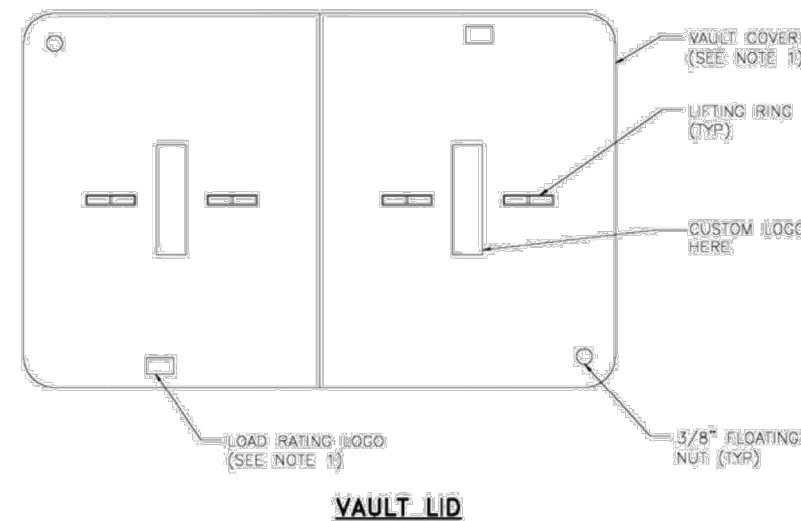
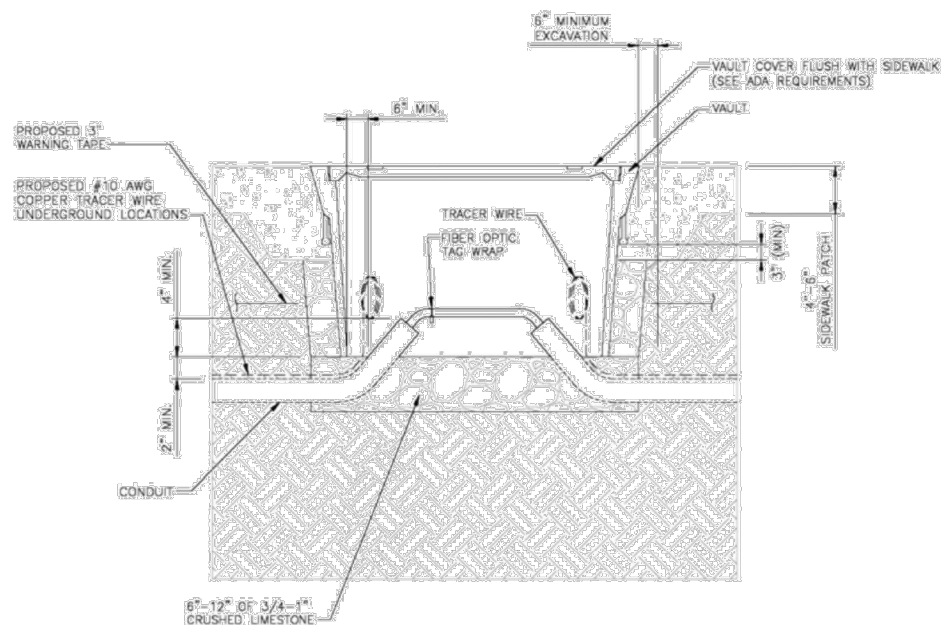

PEDESTRIAN ACCESS ROUTE

VAULT W/ BOTTOM ENTRY

VAULT LID

REV	DATE	DESCRIPTION	BY
A	08/23/23	ISSUED FOR REVIEW	NS
B	08/29/23	REVISED	NS

I HEREBY CERTIFY THAT THESE DRAWINGS WERE PREPARED BY ME OR UNDER MY DIRECT SUPERVISION AND CONTROL, AND TO THE BEST OF MY KNOWLEDGE AND BELIEF COMPLY WITH THE REQUIREMENTS OF ALL APPLICABLE CODES.

TASK NAME

WILC013-U-S5

TASK DESCRIPTION
FIBE OPTIC CONDUIT PLACEMENT

PROJECT AREA
LACROSSE, WI, USA

SHEET SCALE
N.T.S.

SHEET TITLE
DETAILS

GRID NUMBER

SHEET NUMBER
D-4

REV	DATE	DESCRIPTION	BY
A	08/23/23	ISSUED FOR REVIEW	NS
B	08/29/23	REVISED	NS

I HEREBY CERTIFY THAT THESE DRAWINGS WERE PREPARED BY ME OR UNDER MY DIRECT SUPERVISION AND CONTROL, AND TO THE BEST OF MY KNOWLEDGE AND BELIEF COMPLY WITH THE REQUIREMENTS OF ALL APPLICABLE CODES.

TASK NAME
WILC013-U-S5

TASK DESCRIPTION
FIBE OPTIC CONDUIT PLACEMENT

PROJECT AREA
 LACROSSE, WI, USA

SHEET SCALE
 N.T.S.

SHEET TITLE
TRAFFIC CONTROL STANDARD DETAILS

GRID NUMBER

SHEET NUMBER
TCP-1

Sidewalk Closure
 (Pedestrian Detour)

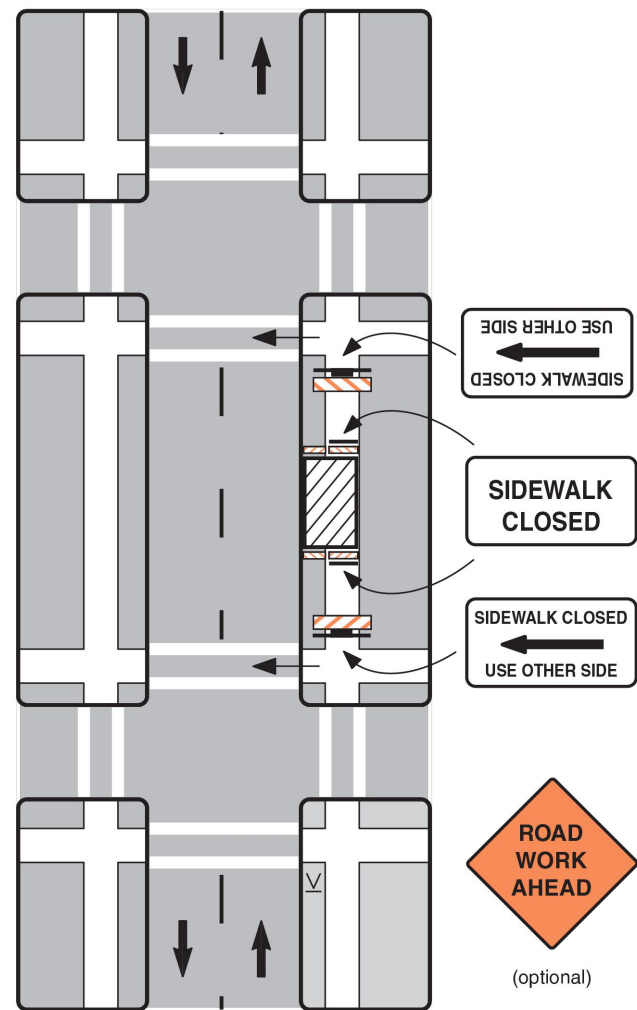

Notes

1. Additional advance warning may be necessary.
2. Only the traffic control devices related to pedestrians are shown. Other devices may be needed to control traffic on the streets such as lane closure signs, ROAD NARROWS or LANE NARROWS signs.
3. For nighttime closures, Type A flashing warning lights may be used on barricades supporting signs and closing walkways.
4. Audible devices should be considered to alert pedestrians with visual disabilities of closings and crosswalk changes.

Sidewalk Closure
 (Pedestrian Walkway Provided)

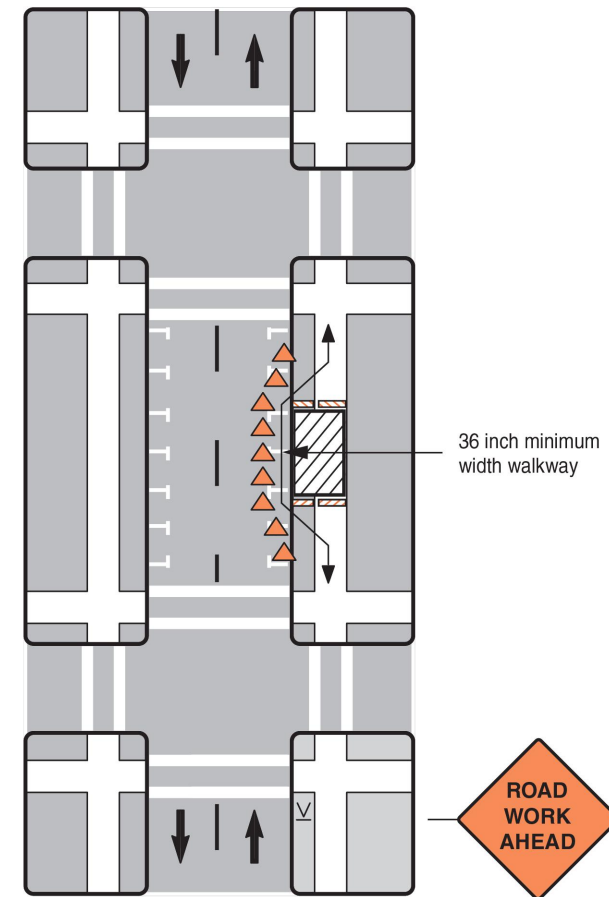

Notes

1. Additional advance warning may be necessary.
2. Only the traffic control devices related to pedestrians are shown. Other devices such as lane closure signs, ROAD NARROWS or LANE NARROWS signs may be needed to control traffic on the streets.
3. For nighttime closures, Type A flashing warning lights may be used on barricades supporting signs and closing walkways. Type C or Type D steady-burn lights may be used on channelizing devices separating the temporary walkway from vehicular traffic.
4. Where high speeds are likely, a barrier should separate the temporary walkway from vehicular traffic. Refer to Section 6D.01 of Part 6 of the MUTCD for information on barriers.
5. Signs may be placed along a temporary walkway to guide pedestrians; for example, Keep Right or Keep Left signs.
6. Pedestrian walkways should be ADA accessible (i.e., ramps, surfaces).